

Kelunji EchoPro Crack and Structural Monitoring System

User Manual for Installation, Data Collection, and Data Analysis.



Thomas Koegel

Table of Contents

User Manual.....	3
Introduction	3
Kelunji EchoPro Setup	6
Sensor Installation	10
LARCOR Compliance Seismograph Setup	15
Integration of compliance seismograph as ground motion and air overpressure trigger.....	17
Sensor Wiring.....	19
EchoPro Analysis – Software, Scripts, and Templates	21
Generating Output Reports	36
Appendices.....	43
Appendix A - Kelunji EchoPro Recording Unit.....	43
Appendix B - Connector Boxes.....	46
Appendix C - Geophones.....	52
Appendix D - LVDT's	55
Appendix E - Temperature & Humidity Logger.....	59
Appendix F - LARCOR – Kelunji Serial Splitter	62
Appendix G - Setting Trigger Levels	64
Appendix H - Field Computation.....	67
Appendix I - Excel Analysis Templates	69
Appendix J - Filtering and Storage of Data.....	79
Appendix K – Sample Data Practice Example: Excel Templates	83
Appendix L - Excel Template Modifications.....	94

User Manual

Introduction

This manual describes use of a new hybrid autonomous crack and structural response monitoring (ACSM) system. It is designed as a low cost alternative to the research grade version employing SOMAT's eDAQ data recording system. The concept is to combine a new field portable, 24 bit, 12 channel seismograph with a compliance seismograph. The 24 bit seismograph monitors the crack and structural response, while the compliance seismograph monitors ground motions and air over pressures. While this manual specifically describes use of a Kelunji EchoPro 24 bit seismograph linked with a LARCOR compliance seismograph, other compliance seismograph could be employed with the system with a minimum of effort.

As configured the Kelunji EchoPro (KEP) recorder can autonomously monitor crack and structural response in a wide range of field configurations. Cost and simplicity were the main priorities for design of the hybrid system. The full installation, illustrated in Figure 1 includes structural response velocity and crack sensors, a LARCOR compliance seismograph with a trigger connection, connector boxes, and the KEP unit. The KEP and connector boxes organized in a field container are shown in Figure 2. Data collected with the device can be manipulated and visually communicated quickly and effectively with excel-based scripts and templates developed specifically for use with the KEP.

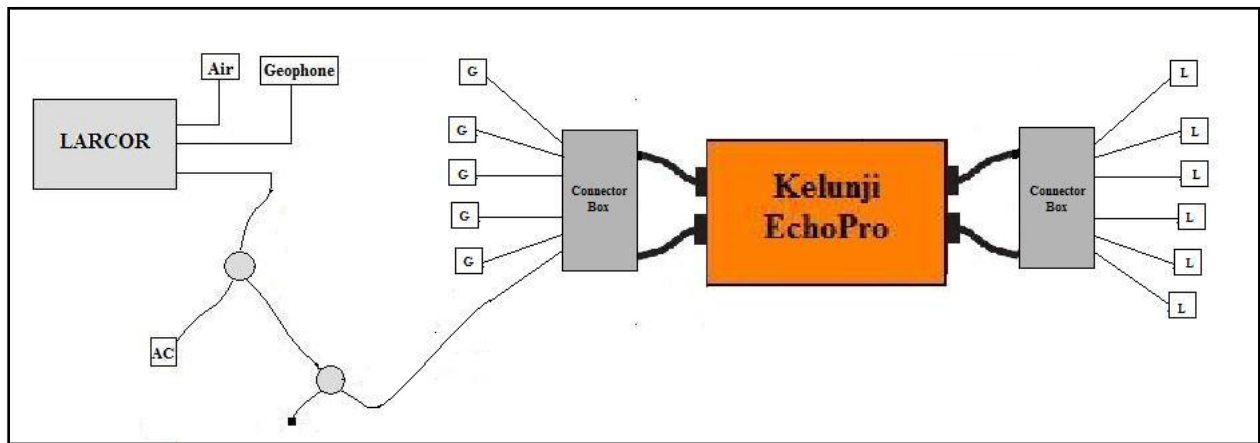

Figure 1: Components of the hybrid autonomous crack & structural monitoring (ACSM) system

The hybrid ACSM system monitors both long term movements of the cracks and responses to transient events both within and outside of the structure. Data files are saved locally to a USB storage device with in the KEP. The system can autonomously record for long time periods with monthly replacements of the memory device. This month long storage potential matches typical site inspection periods and storage potentials of compliance seismographs.

The system is accompanied by a dedicated net book computer to manipulate the raw data and produce graphical reports in a semi-autonomous fashion. This net book computer replaces some of the functionality of the back-end central computer employed in the research grade autonomous monitoring systems employed by the Infrastructure Technology Institute at Northwestern University. The entire configuration, KEP, sensors, compliance seismograph, and net book are meant to operate as a system. Thus a good deal of this manual is devoted to use of the dedicated software in the netbook portion of the system.

The purpose of this user manual is to explain the necessary steps to deploy the Kelunji EchoPro in the field. Physical aspects of installation, operation of the hybrid system, and graphical report generation are described in this manual. Not included are specific steps in manufacturing specific components or other more technical discussions. Following the instructions allows the operation of the full hybrid system as well as the production of graphical reports that compare long term and transient crack response.



Figure 2: KEP and connector boxes in field container

This user manual is divided into specific sections, each detailing a particular aspect of the installation or operation of the system. The installation of the system includes KEP Setup, Sensor Installation, LARCOR Compliance Seismograph Setup, Integration of the Compliance Seismograph, and Sensor Wiring. The EchoPro Analysis and Generating Output Reports sections discuss the data analysis and the important features of an output report. Appendices include more details about the individual system components, scripts and templates, system setup, and other considerations.

Kelunji EchoPro Setup

Powering

Power for the Kelunji EchoPro recorder is supplied by a 12V DC battery or a regulated 12V DC power supply. For the first option, it is important to replace or recharge the battery when it runs low. For the second option, the regulated power supply can be plugged into an active electric outlet. More information on powering the unit can be found in Appendix A or the Kelunji EchoPro user manual.

Connector Boxes

The next step in preparing the EchoPro is to attach the two connector boxes. These are shown on the left and right side of Figure 4. Each box is labeled by its channel numbers and its corresponding Kelunji ports (A, B, C, D) as described in appendices A and B. These ports are located in the front right, back right, back left, and front left respectively. To connect the boxes, the two bayonet cables from each must be connected to the correct port on the EchoPro recorder. Ports “A” and “B” are attached to the powered connector box, which transmits sensor channels one through six. LVDTs are connected to these channels. Ports “C” and “D” are attached to the unpowered box, which transmits sensor channels seven through twelve. Geophones and an external trigger can be connected to these channels. These connectors and connections are described in detail in Appendix B.

System Storage

In the field, it is important for the system to be housed in a secure location as shown in Figure 3 through Figure 5. For a previous deployment, a plastic bin about three feet long, one and a half feet wide, and two feet tall was utilized. To help organize the bin, the connector boxes should be adhered to the sides with double-sided Velcro tape or another viable method after being connected to the EchoPro recorder. Also, a slot should be cut out of the back for the sensor wires to enter the bin. Place the 12V regulated power supply or battery on the opposite end of the bin, along with any other necessary system components. Figure 3 through Figure 5 below show the system fully connected and organized within the storage bin



Figure 3: EchoPro Storage Bin – Open

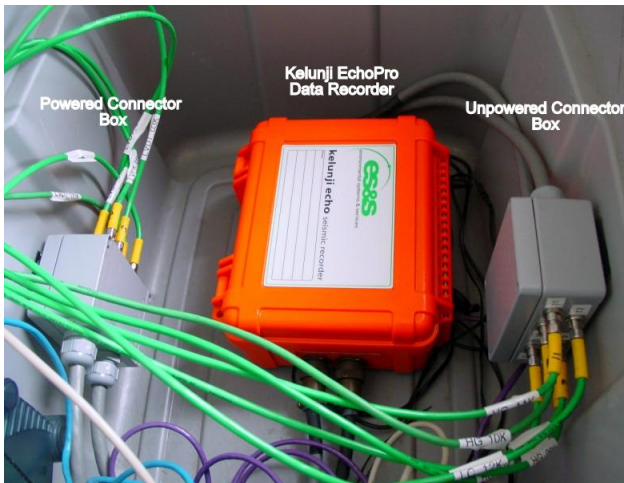

Figure 4: EchoPro Storage Bin - Close-up



Figure 5: EchoPro Storage Bin - Closed

Data Storage

The Kelunji EchoPro recorder requires an external source of data storage. It can be archived externally with an internet connection or saved to a local USB memory device. The simplest method is to use a flash (thumb) drive with a large amount of storage capacity.

The memory device connects to the Kelunji EchoPro in the USB port shown in Figure 6. The EchoPro should be powered off when inserting the storage drive. Once it is put in the unit, the EchoPro can be powered on and the device status can be checked with the USB storage info link on the left side of the main menu screen. If working properly, the name of the drive and the available memory should display in the window.

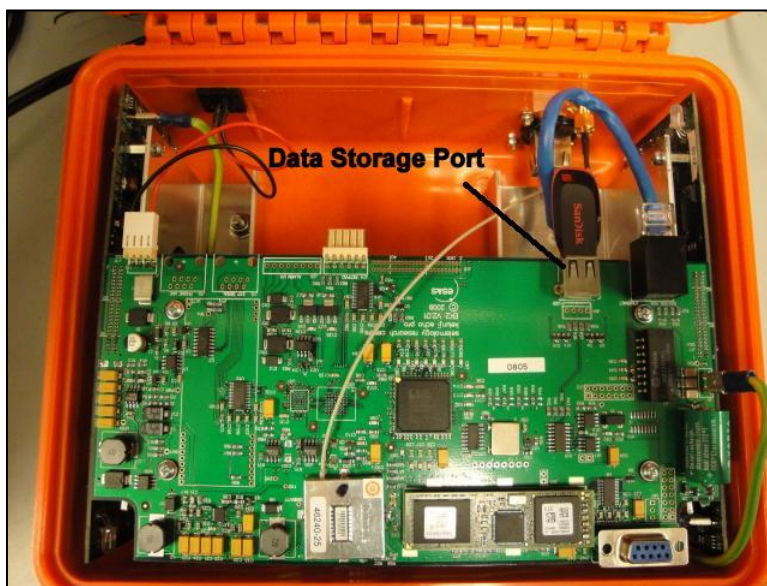

Figure 6: Location of Data Storage Port inside the EchoPro Recorder

Similar to the installation of the USB drive, removal of the drive requires the unit to be powered off to ensure data is not corrupted. Then, the device can be removed from the EchoPro to retrieve the data. At this point, either a replacement flash drive should be installed or the original can be reused if the data is first transferred to an external hard drive. If the second option is taken, it is important to ensure the data copied correctly and then clear the USB storage device before reinserting it into the EchoPro. The recorder can then be restarted and data acquisition can continue.

Starting Data Collection

It is important to start the Kelunji EchoPro recording process once the unit is installed and ready to record data. Also, the recorder needs to be turned on during the process of centering the LVDT targets.

Data collection can be stopped or started from the netbook while connected to the web-based EchoPro interface. To start the system, connect the netbook to the recorder via the crossover cable and use the IP address as the URL in a web browser. It will ask for a log in name and password, which is by default “Kelunji” and “secret” respectively. Once at the Kelunji main menu, turn on the recorder with the button in the upper left hand corner shown in Figure 7. If there are no conflicts, the unit will begin data capture. While the recording process is on, the current signal values of the sensors can be viewed by selecting the appropriate link in the menu.

****Note:** Data capture can only be started if a viable data storage method is installed.

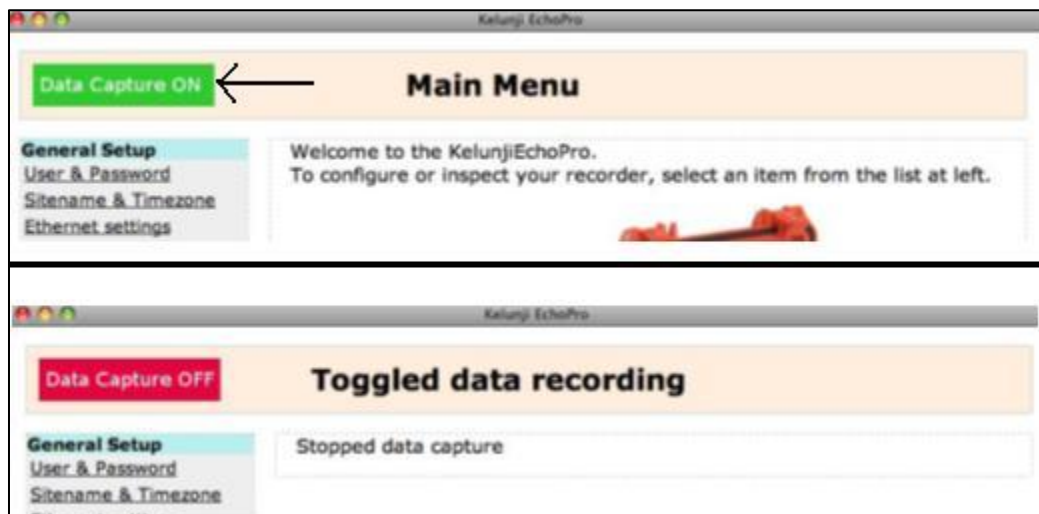

Figure 7: Starting and Stopping Data Capture on the Kelunji EchoPro Recorder

Sensor Installation

Objective

This section shows the process of sensor installation for use with the EchoPro recorder. Most of these processes can be completed concurrently and the organization below does not represent a timeline. However, there are certain steps in this manual that require a previous step to be completed first. These exceptions will be noted.

Process

Sensor installation of a test site includes the LVDT displacement transducers for crack monitoring, the geophone velocity transducers for structural monitoring, and the SUPCO temperature and humidity gauges for interior and exterior recording. The final position of each sensor should be measured and each sensor should be labeled by channel number. More information on these sensors can be found in appendices C, D, and E.

-LVDTs

Installing the LVDTs requires two main steps: mounting the sensors and setting targets. The process of mounting the sensors begins with identifying the cracks that need to be monitored. Assuming these are known ahead of time, the exact placement of the sensors relative to the cracks is important. LVDTs must be setup at a point where the crack is “in-plane”, meaning that the LVDT body and target will be perfectly parallel to each other when mounted. Also, the LVDT body needs to be close to (within a few mm) but not touching the crack to be monitored.

With the sensor placement determined, the LVDT body can be secured to the wall with 60 or 90 second epoxy. Make sure to mix the epoxy well and to hold the body firmly to the wall until it is secure. Duct tape can be used after this period to prevent sensor movement and guarantee the epoxy will have time to fully set. Photographs for this process are shown in Figure 8 and Figure 9 below.



Figure 8: LVDT Body - Epoxied to Wall



Figure 9: Applying Pressure while Epoxying LVDT

Setting the sensor targets is a difficult but crucial step for the correct installation of the LVDTs. Before this step can occur, the LVDT must be connected to the fully prepared EchoPro recorder. Therefore, this is one of the last operations to perform when installing the system.

The key to correct positioning of the sensor target (and LVDT core) includes 3 major criteria:

1. Target must be in the nominal range (0.1 inches for the LVDTs at Sycamore)
2. Target should be centered in the nominal range
3. LVDT core must be parallel to LVDT body

Figure 10 through Figure 13 below show the completed installation of the sensors. The steps required to achieve these results are as follows. One individual must monitor the sensor output with the netbook connected to the Kelunji EchoPro. Refer to the EchoPro user manual for detailed explanation of how to accomplish this. Once the current sensor outputs are being monitored, a second person can apply 90-second epoxy to the sensor target base. The second person should begin pressing the target to the wall while moving the LVDT core and screw into the body. To ensure the core is parallel to the body (criterion 3), a small drinking straw can be placed on the end of the core when moving it into the LVDT body and then pulled through the opposite side of the LVDT.

Once the monitoring individual detects the sensor has moved into the nominal range, he or she must communicate this fact with the person installing the target. Then, directions of whether the sensor must be moved inward (to increase the output) or outward (to decrease the output) must be relayed. This process must continue until the target output should be between 3.5 million and

5.5 million A/D steps with an ideal center value of 4.2 million. Once again, duct tape can be used to maintain sensor position until the epoxy hardens.

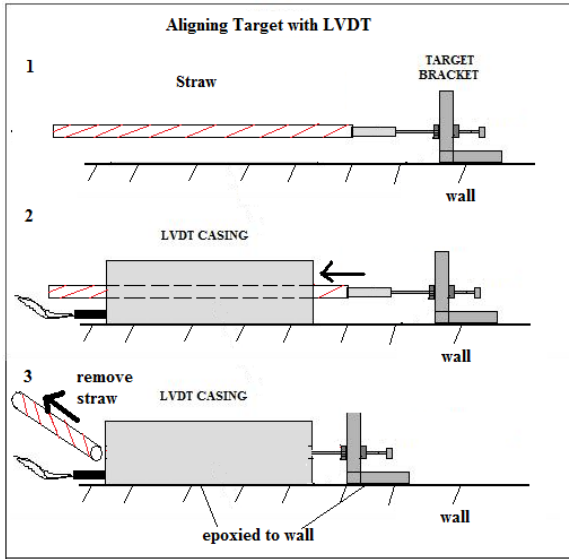

Figure 10: Process for Aligning Target with LVDT

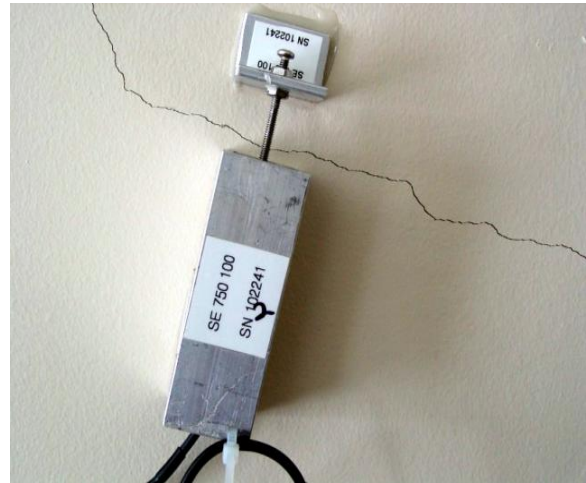

Figure 12: LVDT: Wall



Figure 11: LVDT: Ceiling



Figure 13: LVDT: Taped Target

-Geophones

Proper Geophone installation is shown in Figure 14 through Figure 15 below. Mounting the geophones is accomplished in one of two ways based on the sensor location and orientation. For the horizontal geophones mounted on walls, apply 90 second epoxy to the metal bracket and firmly hold in the desired location until the epoxy hardens. To ensure the sensor does not shift on the wall, use duct tape to hold the geophone in place while the epoxy cures fully.

The process is more complicated for vertical geophones mounted to a ceiling. To ensure that the sensor is adequately attached, it should be bolted to the drywall with screws. A vertical geophone to be mounted in this manner should have a bracket with pre-made holes, as outlined in Appendix C. To install the geophone to the ceiling, drill pilot holes at the sensor position. Then, use screws to secure the bracket to the ceiling (without the geophone). It is best to try to set the screws into a wooden joist when possible. Finally, firmly re-attach the geophone to the bracket with the threaded connection.



Figure 14: Horizontal Geophone: Wall



Figure 15: Vertical Geophone: Ceiling

-SUPCO Temperature and Humidity Logger

Installing the SUPCO loggers in the field is relatively simple. Figure 16 shows a logger installed in the field. Setting up the devices is covered in Appendix E as well as the SUPCO user manual. This step must be completed before they can be deployed in the field.

Once the loggers are prepared, one should be mounted on a wall near the indoor sensors. Make sure that the sensor will not be subjected to direct sunlight because this could throw off the sensor readings. The easiest method for mounting the SUPCO logger is to use double-sided Velcro tape. Velcro is preferred because it allows for the logger to be temporarily taken down for data retrieval and then replaced. The other one should be mounted on an exterior wall in a place where it will be protected from rain and direct sunlight. A good location could be underneath a roof overhang or other source of shade and protection.

Once installed, ensure that the logger is recording data by looking at the indicator light in the bottom left corner of the device. If it blinks green once about every 15 seconds, it is recording correctly.



Figure 16: SUPCO Temperature and Humidity Gauge

LARCOR Compliance Seismograph Setup

The LARCOR Compliance Seismograph and its sensors will be connected the Kelunji EchoPro to serve as an external trigger source. Also, the LARCOR will record data on triggered events from its air overpressure sensor and tri-axial geophone.

****Note:** If the LARCOR system is already installed at a given location, **skip** this section.

The first step is to setup the systems sensors for long term installation. Attach the air overpressure sensor to the exterior wall of the house with bolts or another viable method as in Figure 18. Then, connect it to the corresponding port on the LARCOR. Bury the tri-axial geophone six to twelve inches underground, positioned flat and perpendicular to the wall of the house. Figure 17 shows the installation of the geophone.



Figure 17: Triaxial Geophone – Buried

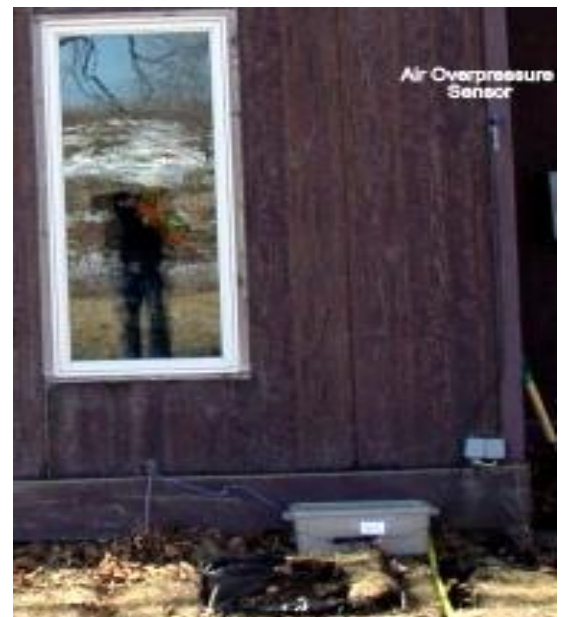

Figure 18: LARCOR with Air Overpressure Sensor

Place the LARCOR seismograph inside a weatherproof bin and cut small slits into the sides for the necessary wiring. To connect with the internal system, drill a small hole in the exterior wall or determine an adequate pre-existing opening to run the serial wire inside. This serial wire is split to the power source and split again to connect with the Kelunji. It can also be used to connect the system to the internet. For information related to the trigger connection cable with the Kelunji, see Appendix F. Seal the bin by placing a heavy object on the lid to ensure it remains stable and closed. Figure 19-Figure 22 show the process and final results of an installation. For more information on the LARCOR, reference the user manual for a given model



Figure 19: LARCOR Compliance Seismograph

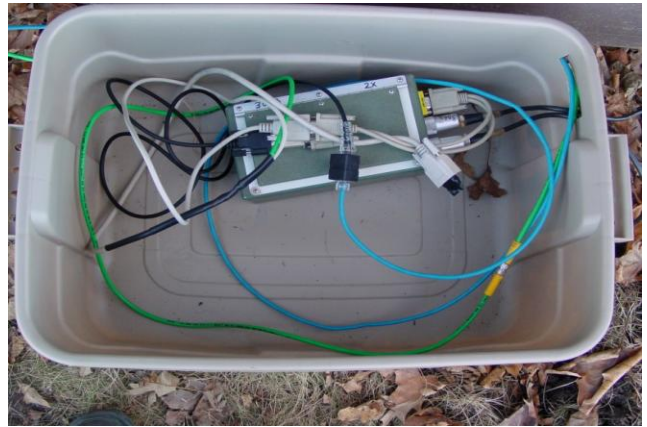

Figure 21: LARCOR Tub Organization



Figure 20: LARCOR- Wiring to Inside



Figure 22: LARCOR Final Setup

Integration of compliance seismograph as ground motion and air overpressure trigger

Objective

The LARCOR seismograph, the typical compliance hardware used by regulators, can be adjusted to serve as a trigger to the Kelunji EchoPro for a specific level of air overpressure or ground motion. This combination allows for an integration of the systems that more completely monitors key dynamic responses.

LARCOR triggering setup

The LARCOR unit, the use of which will not be outlined here (refer to the user manual for operating instructions), can be programmed to record dynamic data given a specific threshold of air overpressure or ground particle velocity from its air blast sensor and geophone sensors respectively. For monitoring purposes, this recording process can be set to begin when the geophone detected ground motions of at least 0.04 in/s or air overpressures of at least 120 dB. However, site specific values should be used to try to capture only the relevant data.

When a trigger threshold is exceeded, the LARCOR unit can be setup to output a 5V square trigger pulse through its serial output. However, in order for the trigger pulse to reach the EchoPro recorder, an additional serial splitter cable is needed. As shown in Figure 23 below, the serial output must be split first with the provided LARCOR splitter to an AC power source and a second branch. This second branch is further split with the new splitter to a free branch and a branch connected to a Turck Picofast male cable. This male cable should be plugged into the EchoPro connector box or an extension cable (as needed). With this setup, the LARCOR trigger pulse will be received by connected Kelunji port (typically channel 12 of port D, but any channel will function correctly). The details of manufacturing the new splitter cable are discussed in Appendix F.

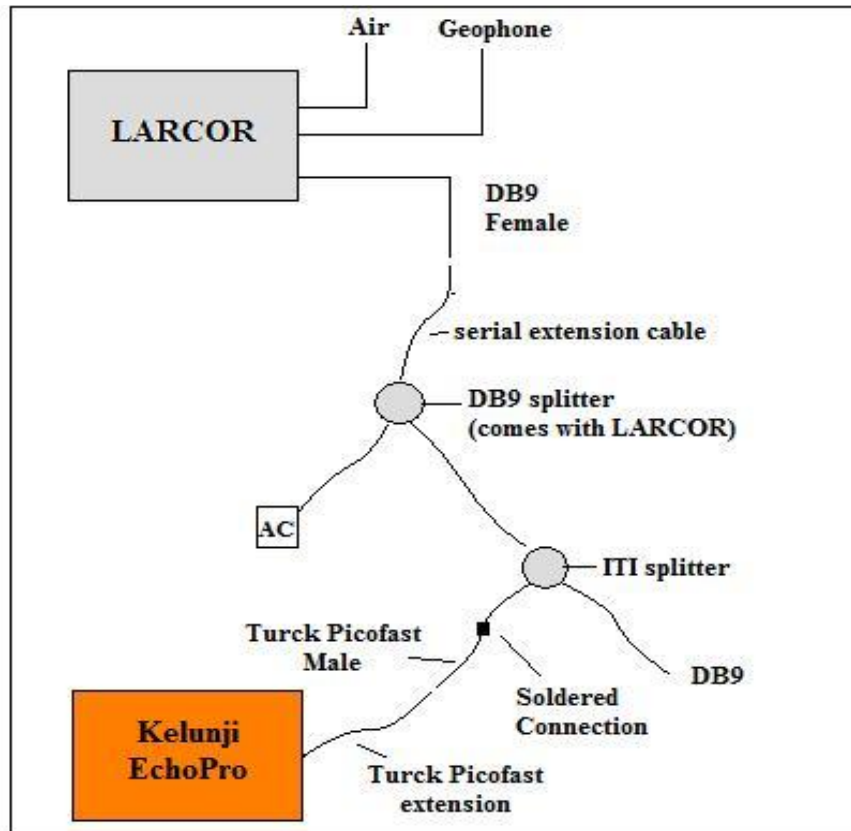

Figure 23: Figure 30: LARCOR to Kelunji EchoPro Connection Diagram

Kelunji External Triggering Process

To trigger the Kelunji with the LARCOR trigger, a separate trigger “level” process needs to be created with a threshold level of 45% of the 10 volt range. This process can be programmed to record all the connected sensors for a set amount of time, including pre-trigger data, and store the files in a separate folder specific for these triggered events. For more technical details of the triggering process, please refer to Appendix G – Setting Trigger Levels.

Sensor Wiring

The final step to the installation of the system is the wiring. The sensors are connected to the EchoPro recorder via the connector boxes with Turck Picofast cables. These cables can be purchased in lengths of two, five, and ten meters. It is important to plan ahead for wire lengths.

Important Considerations

When wiring the sensors to the EchoPro recorder, there are a few important considerations to account for. First, drilling through walls should be avoided unless absolutely necessary. The wires can be routed by normal means through the house. The exception to this rule is the wiring from the LARCOR seismograph to the EchoPro, which may need to run through the exterior wall. Second, wires should be labeled and organized in a way that is clear and will protect the wires from damage. This is outlined further in the sections below. Finally, wires exposed to the environment must be protected with weatherproof material at the connections to protect the system from the elements.

Labeling

It is vital for wires to be labeled by its channel number or some other labeling method. This can be accomplished with the two options shown in Figure 24. The first option is to use a label maker to mark each cable by its unique designation. The second option is to write the label at the connection points with a permanent marker. Also, the labeling system should be documented at the time of installation as a reference to avoid any possible confusion.

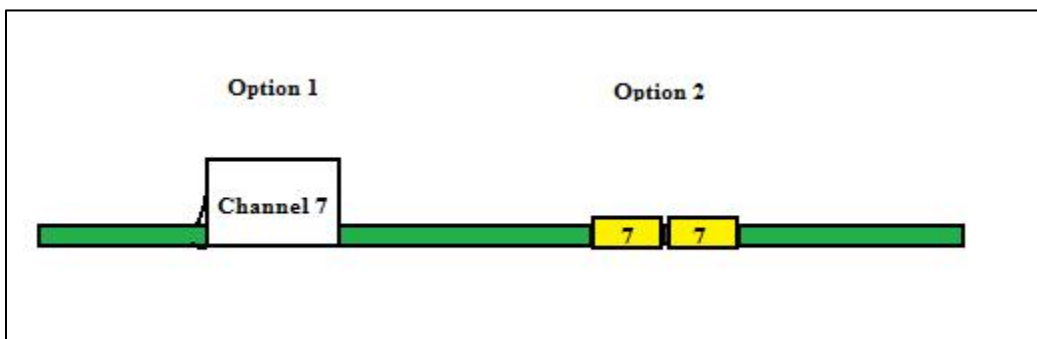

Figure 24: Labeling Options for Turck Picofast Cables

Organization

An organized system of wiring is essential to an installation that can conserve both time and material. It also protects the cables from damage while deployed in the field. The wires must be bundled with cable ties and secured to the walls or ceiling with Command hooks. The figures below photographically describe the proper method of organizing cables on site.

Proper planning can assist in this process. If the length of cable necessary between the recorder and the EchoPro is calculated ahead of time, appropriate cable lengths can be used. This helps to reduce extra lengths of cable that can hamper the organization.

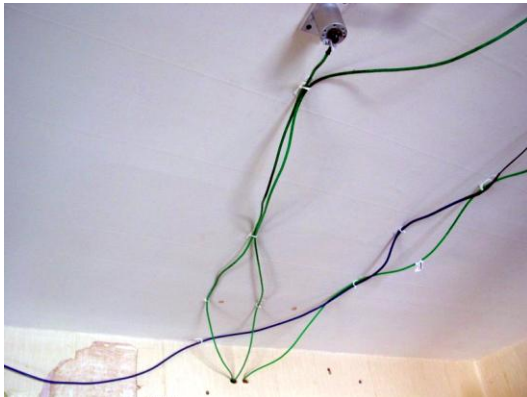

Figure 25: Example Ceiling Wiring



Figure 27: Example Wall Wiring



Figure 26: Example Wiring Between Floors



Figure 28: Securing Wires to Wall

EchoPro Analysis – Software, Scripts, and Templates

Objective

The use of software, scripts, and templates simplifies and automates the process of changing raw data into final tables and plots that can be used within a report. The scripts and templates were developed specifically for use with the Kelunji EchoPro recorder and the installation described within this user manual.

Kelunji Filtering Script

The Kelunji EchoPro filtering script extracts data from the USB storage device, typically a flash (thumb) drive, filters it, and saves the data into two separate types of files. Burst data files are saved as text files and labeled by the time stamp of the event. Long term data is filtered and compiled into a single text file. More information on this process and the results can be seen in Appendix J.

The steps required to execute this filtering script are as follows:

1. Ensure that the AutoHotKey program is installed on the netbook.
2. Plug the USB storage device into the netbook.
3. Open the Kelunji software folder on the desktop and then the conversion scripts folder
4. Double-click the file “Kelunji Filter Script”
(If there is an error when running the script, see the Note section below)
5. Wait until the script finishes (the process may take up to an hour). When it finishes, a notification will appear on the screen. While the script is running, the AutoHotKey icon will display in the bottom right corner of the screen, as shown in Figure 29

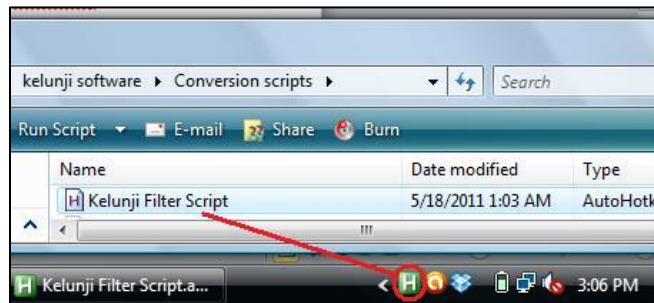

Figure 29: Kelunji Script Execution and System Tray Icon

6. Once the script finishes, a folder with the date and time the script was executed should appear on the desktop. This folder should contain three things if the script was executed properly: a temp directory, converted burst text, an hourly averages file of the long term data.
7. If the script ran correctly, this data can be used in the excel analysis templates, whose process is outlined below.

Note: If an error occurs while the script occurs, it is likely that the input directory or output directory was not found. Right click the script and open it with a text editor such as notepad. Find the input directory near the top of the file and ensure that it is searching in the same drive letter as the USB flash drive. If this is not the issue, find the output directory and make sure it is set to the desktop. If these attempts do not solve the issue, contact the developers of the script.

Additional Data Sources

Data from sources other than the Kelunji EchoPro recorder are necessary for the proper use of the excel templates. The long term data should include temperature and humidity data from the SUPCO loggers and the dynamic event data should include external ground motion and air blast data from the LARCOR compliance seismograph. Information on retrieving data from the SUPCO units is available in Appendix E. The procedure to obtain data from the LARCOR unit can be found in the LARCOR user manual. The important consideration is that all files should be saved to either text or excel compatible formats for use in the excel templates.

Excel Templates

Each excel template procedure outlined below can be practiced using the data provided in the “template example files” folder. Graphs of the proper outputs and more information about this sample data can be found in Appendix K.

-Long Term Template Procedure

1. **Start** Microsoft Excel
2. **Locate** and **Open** the following files. For the hourly_averages file, select fixed width in the text input wizard shown in Figure 30 and click finish. For the temperature data, select fixed width and click next. Then, as shown in Figure 31 double click and eliminate the two columns between date and time and create a column on the right side of time.
 - a. Hourly_averages (Kelunji EchoPro long term data – in folder on desktop)
 - b. Internal and external temperature data (SUPCO logger data – saved to desktop)

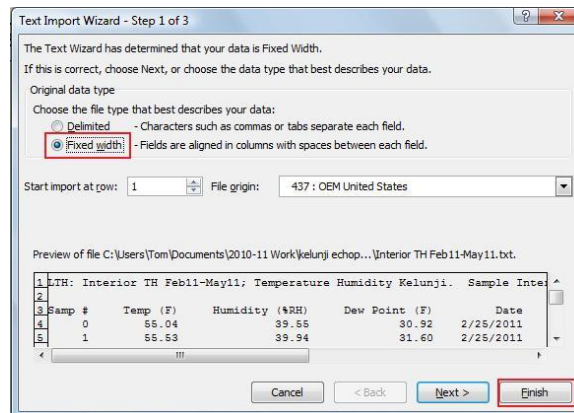

Figure 30: Excel Text Import Wizard with Correct Options Highlighted

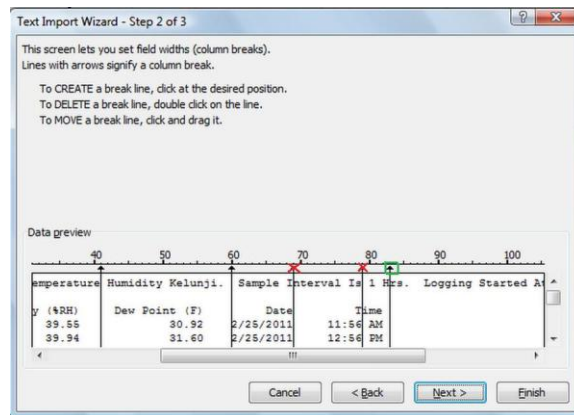

Figure 31: Excel Text Import for SUPCO data

****Note:** Figure 32 and

Figure 34 show the empty and completed templates respectively. These figures should be referenced as needed.

3. **Copy** all of the columns of data from the **hourly_averages** excel document. **Paste** this data into the section titled “Paste EchoPro Values Below” and labeled by the number 2. Pasting, as shown in Figure 32, is accomplished by right clicking and selecting paste – values.

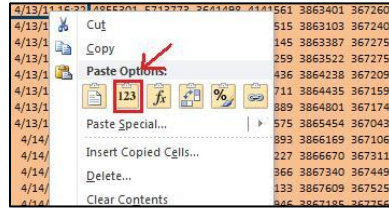

Figure 32: Correctly Pasting Values into the Template

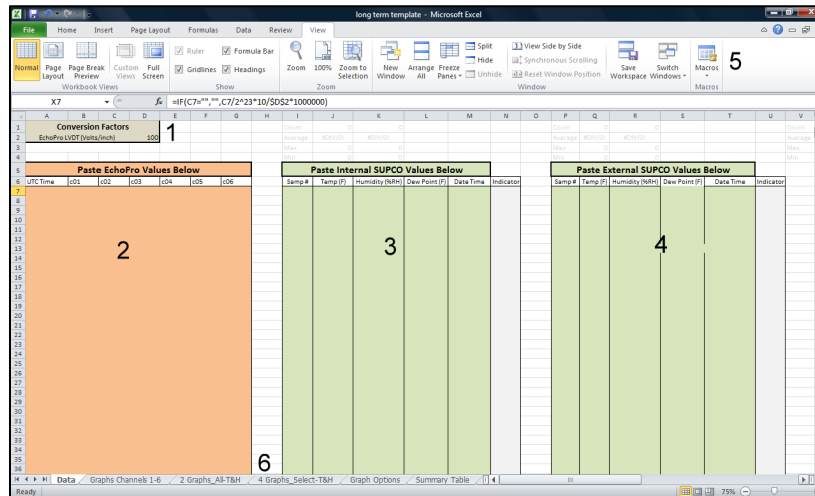

Figure 33: Long Term Template with Important Regions Numbered

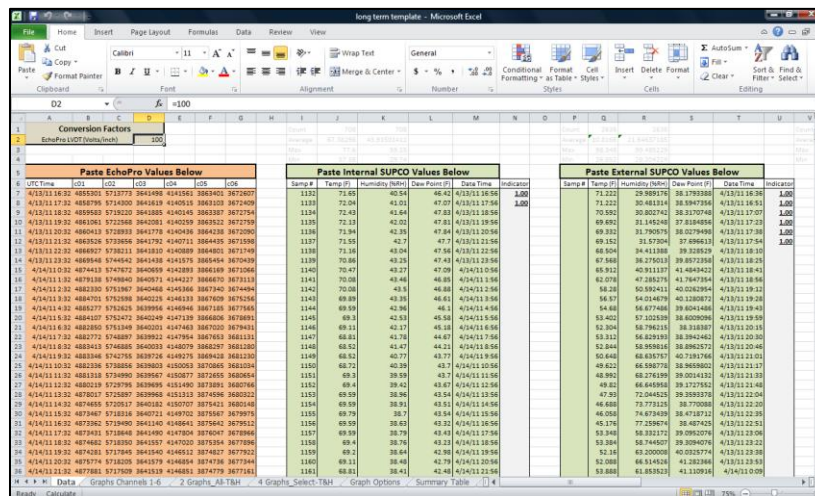

Figure 34: Long Term Template with Data Inputted

4. **Repeat** step 3 for the internal SUPCO values in region 3 and the external SUPCO values in region 4. All the necessary data should now be within the template file.
 5. Look at the **indicator** column for the internal SUPCO data. **Scroll** down in the document and find the first value of “1” in a given cell. **Highlight** all of the data within the green fields above this row.
 6. Press the **Delete** key (not the excel function), then copy the remaining data in the fields from the first indicator down to the end.
 7. Paste (values) into the top of the green area (row 7). Delete data below this pasted region.
- **Note:** This step should line up the beginning time of the Kelunji EchoPro data with the temperature and humidity data. To check this, compare the date and time for the first EchoPro row and the first SUPCO row. If they are within a few hours of each other, this is sufficient for the long term plots.
8. **Repeat** Steps 4 through 7 for the external SUPCO data.
 9. Input the **conversion factor** for the crack gauges in the upper left hand corner of the document. The factor should be in **Volts/inch**. This ensures that the data is converted to engineering units correctly. This factor can be found in the specs for the crack sensors.
 10. Click the view tab on the top menu bar and choose the Macros button, which is annotated by the number 5 in Figure 33.
 11. Select View Macros
 12. Choose the macro **Y_axis** and click **Run**, shown in Figure 35.

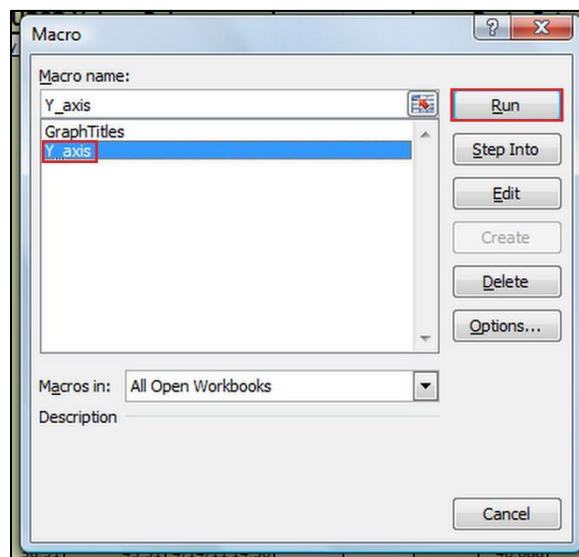

Figure 35: Long Term Template Macro Window with Annotated Selections

13. Switch to the **fifth** spreadsheet tab titled **Graph Options** shown in Figure 36

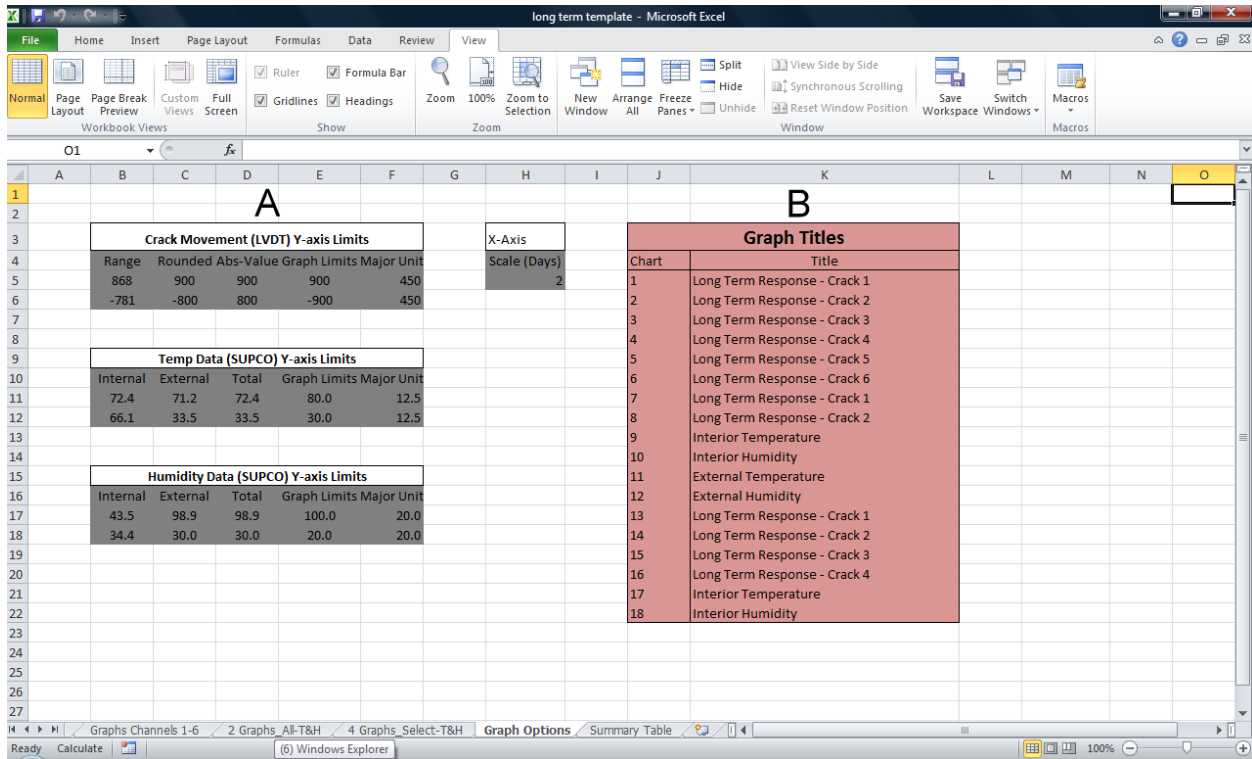

Figure 36: Long Term Template Graph Options Annotated by Letter

14. The graphs should be **renamed** with specific information about the given channel and should include the **crack monitored**. Also, the specific graph scaling can be manually altered in this tab if the automatic scaling did not produce the desired result.

****Note:** If the user decides to manually scale the x-axis or y-axis by entering numbers, the automatic calculations that provided the initial ranges for it will be lost. However, manual scaling can often improve the plots from their initial scaling. Further instruction on manually scaling the axes in the templates is provided in Appendix I.

15. **Repeat** steps 11 and 12 with the macro **X_axis** and **GraphTitles**

****Note:** Tabs two, three, and four display plots of the data. The second tab displays all of the crack channels while the third and fourth tabs have selected crack channels with temperature and humidity data. The selected cracks in the third and fourth tabs can be changed by the user. The process will be outlined in steps 16-19.

16. Left-Click on the graph to be altered.

17. Navigate to the Design tab of the menu bar and click Select Data.

18. Select the data series and click edit, as shown in Figure 37.

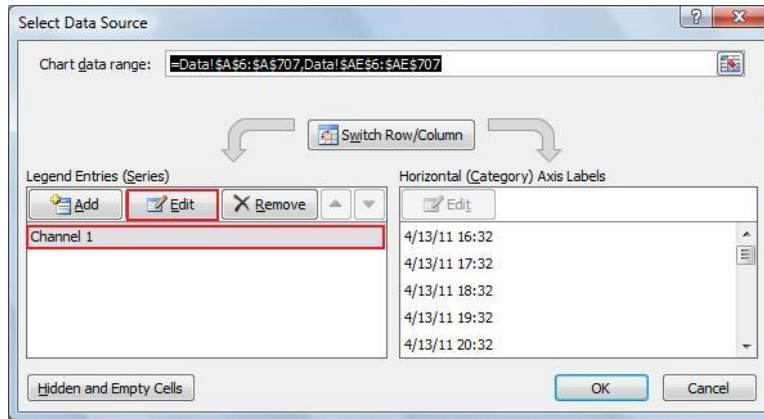

Figure 37: Accessing the Data Source Selection for a Plot

19. In the menu shown in Figure 38, change the number after the word channel to the desired channel source in the **Series Y values** selection box. For Example, Change Channel_1 to Channel_3. Click **OK**.

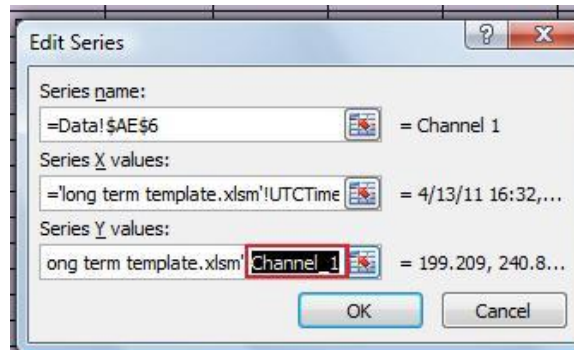

Figure 38: Changing the Crack Channel for a Plot

****Note:** The adjustments to graph sources should not switch graphs from crack movement to the temperature or humidity or vice versa due to the background processes creating the plots.

20. **Select** the sixth tab, titled **Summary Table**, shown in Figure 39.

Title				
Date		Description		
Kelunji EchoPro				
Channel	Description	Maximum	Minimum	Unit
1	Crack Response - Channel 1	0	0	μ-in
2	Crack Response - Channel 2	0	0	μ-in
3	Crack Response - Channel 3	0	0	μ-in
4	Crack Response - Channel 4	0	0	μ-in
5	Crack Response - Channel 5	0	0	μ-in
6	Crack Response - Channel 6	0	0	μ-in
Interior SUPCO Temperature and Humidity Logger				
Channel	Description	Maximum	Minimum	Unit
Temp	Interior Temperature	0.000	0.000	°F
Hum	Interior Humidity	0.000	0.000	%
Exterior SUPCO Temperature and Humidity Logger				
Channel	Description	Maximum	Minimum	Unit
Temp	External Temperature	0.000	0.000	°F
Hum	External Humidity	0.000	0.000	%

Figure 39: Long Term Template Summary Table

21. **Fill in** the title, date, and description fields at the top of the table for the event.
 22. Add a **description** for each channel in the corresponding fields.
- **Note:** The template is fully completed. Unless further changes are desired, continue to steps 23 a-c to print the outputs or 23 d-f to export the outputs to a word processing document.
23. Printing or Moving Outputs.
 - a. Select the tab to be printed.
 - b. Go to File and select Print.
 - c. Make sure Print Active Sheets and the correct printer are selected and click print.

OR

 - d. Highlight the plot or table, right click, and select copy.
 - e. Open Microsoft Word or another word processing program.
 - f. Right Click and Select Paste.

****Note: Sample Outputs** of the plots and the summary table can be viewed in the **Reports** section of the User manual. The x-axis scaling was changed to two days in these plots.

-Dynamic Excitation Procedure

1. **Start** Microsoft Excel
2. **Locate** and **Open** the following files. For each file, select fixed width in the text input wizard shown in Figure 40 and click finish.
 - a. Selected dynamic event (Kelunji EchoPro burst files – in folder on desktop, labeled by date and time of event)
 - b. External sensor data (LARCOR Compliance Seismograph data – saved to desktop)

****Note:** Events that don't trigger the external system won't have data from the LARCOR.

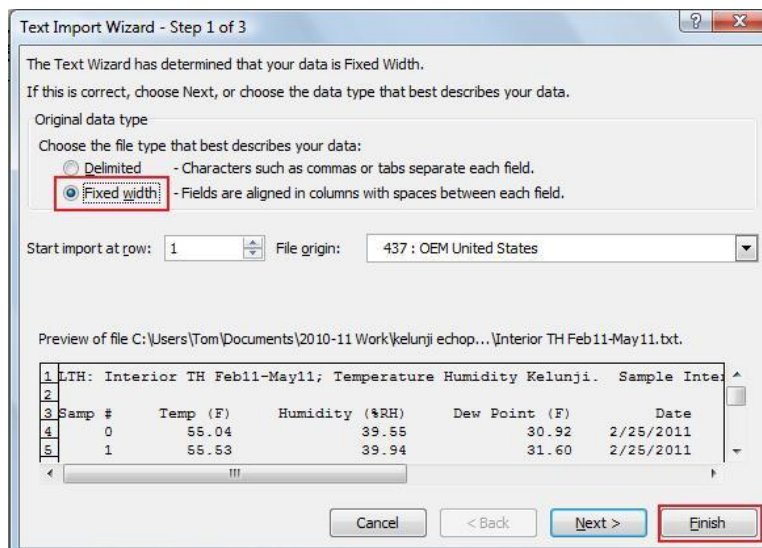

C.

Figure 40: Excel Text Import Wizard with Correct Options Highlighted

****Note:** Figure 42 and Figure 43 show the empty and completed templates respectively. These figures should be referenced as needed.

3. **Copy** all of the output data from the **selected dynamic event** excel document. This data starts at the 85th row of columns B through columns M. **Paste** this data into the section titled "Paste EchoPro Values Below", labeled by the number 2. Pasting, as shown in Figure 41, is accomplished by right clicking and selecting paste – values.

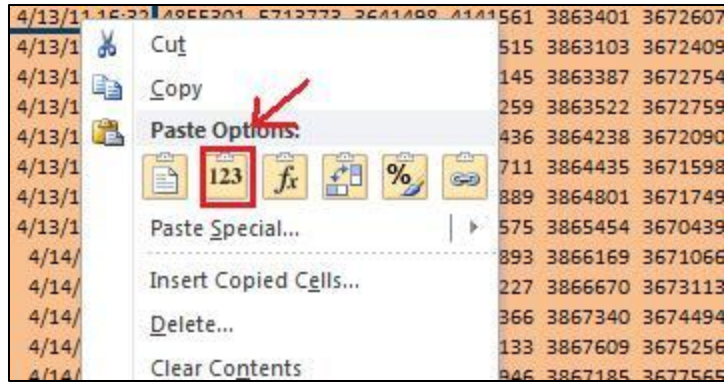

Figure 41: Correctly Pasting Values into the Template

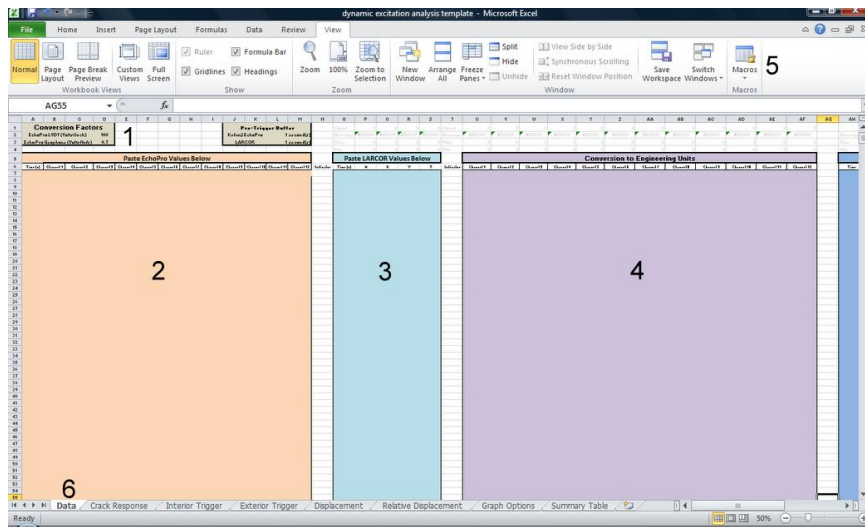

Figure 42: Dynamic Template with Important Regions Numbered

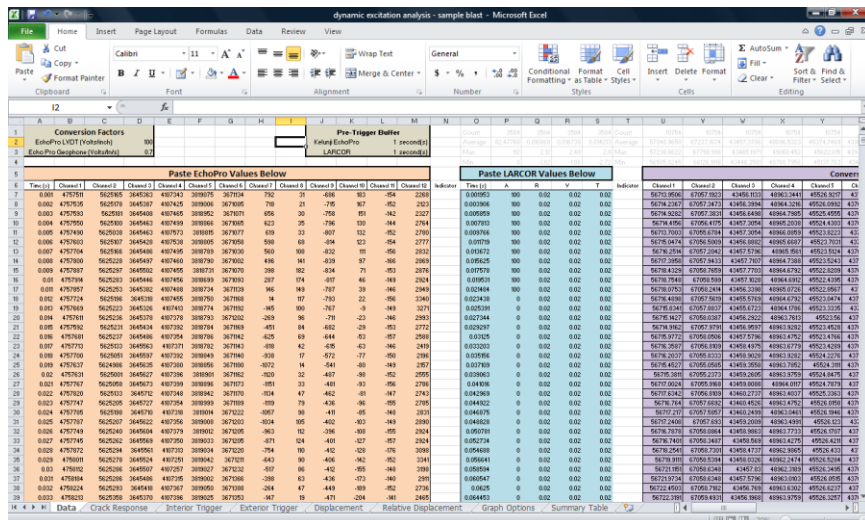

Figure 43: Dynamic Template with Data Inputted

4. **Paste** the LARCOR data in region 3. Make sure to delete all columns except acoustic (dB), radial (in/s), vertical (in/s), transverse (in/s) by right clicking and selecting delete, then delete entire column before transferring the data.
 5. If **LARCOR data** is available, **follow** steps 6-13. If it is not, **skip** to step 14.
 6. Look at the **indicator** column for the LARCOR data and the Kelunji data. **Scroll** down in the document and find the first value of “1” in each cell. **Record** the time value on the same row as each indicator at the top of the document in cells L2 and L3.
 7. **Calculate** the difference between cell L2 minus cell L3 and multiply by 1,000. This is the number of rows of EchoPro data that must be **eliminated** to plot the data correctly.
 8. **Delete** all the EchoPro data from the template (with the keyboard key, not the excel delete function)
 9. Return to the **dynamic data** excel document that was opened from the text file.
 10. **Delete** the first “X” rows of data, based on the calculation in **step 7** by **highlighting** this data, right clicking, selecting **delete**, and selecting option **shift rows up**. When highlighting the data, the number of rows and columns selected is shown by a **small box** adjacent to the cursor (For example, it will show 36R x 12 C if you highlight 36 rows and 12 columns).
 11. **Re-copy** the remaining data back into the excel template in region 2.
 12. **Check** the indicator column for the Kelunji data. The time value of this row should **equal** the time value from the LARCOR data in cell L2.
 13. Replace the number in cell L3 with the new time value.
- **Note:** These steps should line up the Kelunji EchoPro data with the LARCOR data for plotting.
14. Input the **conversion factor** for the crack and velocity sensors in the upper left hand corner of the document. These factors should be in **Volts/inch** and **Volts/inch/second** respectively. This ensures that the data is converted to engineering units correctly.
 15. Click the view tab on the top menu bar and choose the Macros button, which is annotated by the number 5 in Figure 33.
 16. Select View Macros
 17. Choose the macro **Y_axis** and click **Run**, shown in Figure 44.
 18. **Repeat** steps 16 and 17 for the macro **X_axis**.

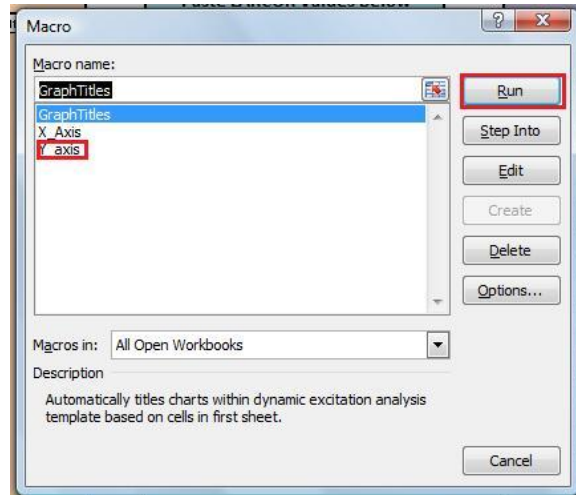

Figure 44: Dynamic Excitation Template Macro Window with Annotated Selections

19. Switch to the **seventh** spreadsheet tab titled **Graph Options** shown in Figure 45.

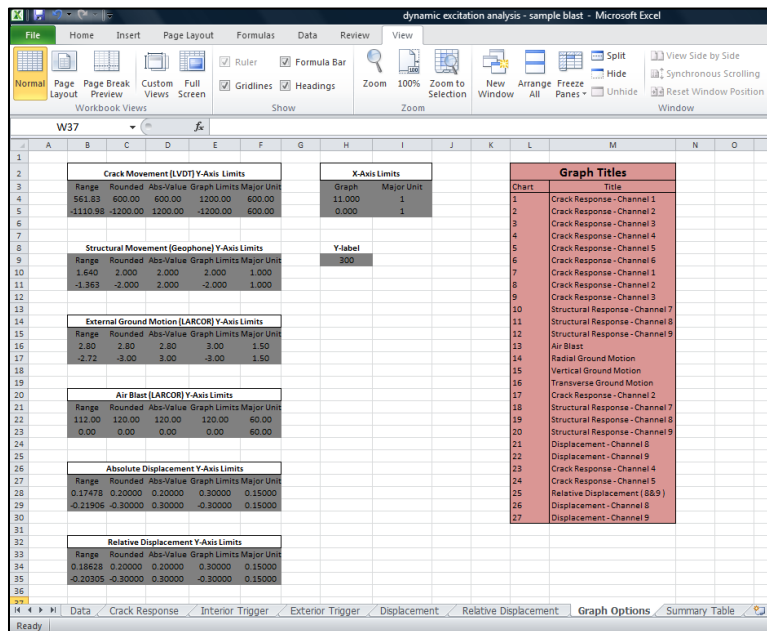

Figure 45: Dynamic Excitation Template Graph Options Annotated by Letter

20. The graphs should be **renamed** with specific information about the given channel and should include what is being monitored. Also, the specific graph scaling can be manually altered in this tab if the automatic scaling did not produce the desired result.

****Note:** If the user decides to manually scale the graphs by entering numbers, the automatic calculations that provided the initial ranges will be lost. However, manual scaling can often improve the plots from their initial scaling. Further instruction on manually scaling the axes in the templates is provided in Appendix I.

21. **Re-open** the Macros window with the same method as in steps **16** and **17**.

22. Choose the macro **GraphTitles** and click **Run**.

****Note:** Tabs two through six display plots of the data. The second tab displays all of the crack channels while the third through sixth tabs have selected channels for the output types. The output channels in the third through sixth tabs can be changed by the user. The process will be outlined in steps 23-29.

23. Left-Click on the graph to be altered.

24. Navigate to the Design tab of the menu bar and click Select Data.

25. Select the data series and click edit, as shown in Figure 46.

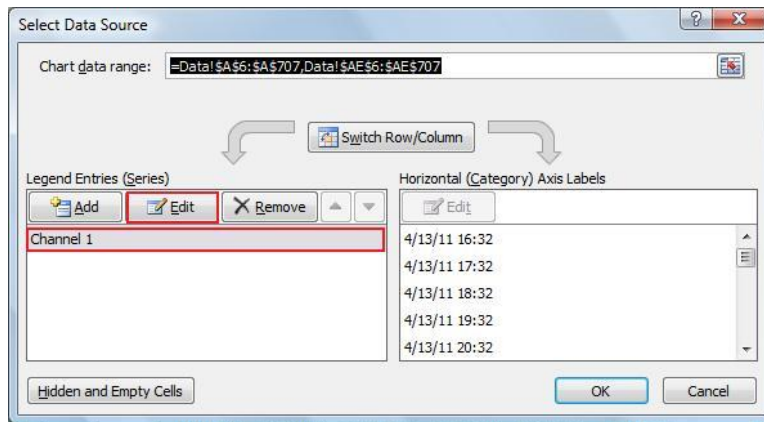

Figure 46: Accessing the Data Source Selection for a Plot

26. In the menu shown in Figure, change the number after the word channel to the desired channel source in the **Series Y values** selection box. For Example, Change Channel_1 to Channel_3 or Channel7_Disp to Channel10_Disp. Click **OK**.

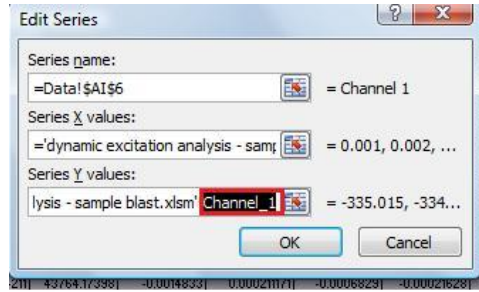

Figure 47: Changing the Channel for a Plot

****Note:** The adjustments to graph sources should not switch graphs from different types of channel sources, such as crack sensor data to velocity sensor data or displacement data, due to the background processes creating the plots of each type.

27. **(optional)** Changing the relative displacement graph can be achieved by changing the excel formula in the first tab of the template. Each cell has the formula:

$$IF(AQ\#="", "", IF(AR\#="", "", AR\#-AQ\#))$$

28. **(optional)** To change the two channels used to calculate relative displacement, replace AR and AQ in the first relative displacement cell (AV7) with the column headings of the selected channels and hit enter.

29. **(optional)** Select the first cell (AV7) and double click the small box that appears in the bottom right corner. This will replace all the cells with the relative displacement of the selected channels.

30. **Select** the eight tab, titled **Summary Table**, shown in Figure 48.

	A	B	C	D	E	F
1		Title				
2		Date	Description			
3						
4		Kelunji EchoPro				
5	Channel	Description	Maximum	Minimum	Unit	
6	1	Crack Response - Channel 1	190	-463	µ-in	
7	2	Crack Response - Channel 2	562	-1111	µ-in	
8	3	Crack Response - Channel 3	8	-11	µ-in	
9	4	Crack Response - Channel 4	164	-136	µ-in	
10	5	Crack Response - Channel 5	247	-237	µ-in	
11	6	Crack Response - Channel 6	84	-400	µ-in	
12	7	Structural Response - Channel 7	1.64	-1.36	in/s	
13	8	Structural Response - Channel 8	0.43	-0.48	in/s	
14	9	Structural Response - Channel 9	0.94	-0.71	in/s	
15	10	Structural Response - Channel 10	0.58	-0.74	in/s	
16	11	Structural Response - Channel 11	0.00	0.00	in/s	
17	12	Trigger Signal - Channel 12	5.03	0.00	Volts	
18		LARCOR Seismograph				
19	Channel	Description	Maximum	Minimum	Unit	
20	A	Air Blast	112	0	Decibels	
21	R	Radial Ground Motion	2.12	-1.82	in/s	
22	V	Vertical Ground Motion	2.48	-1.86	in/s	
23	T	Transverse Ground Motion	2.8	-2.72	in/s	
24		Displacement				
25	Channel	Description	Maximum	Minimum	Unit	
26	7	Absolute Displacement - Channel 7	0.175	-0.219	milli-in	
27	8	Absolute Displacement - Channel 8	0.091	-0.072	milli-in	
28	9	Absolute Displacement - Channel 9	0.140	-0.141	milli-in	
29	10	Absolute Displacement - Channel 10	0.053	-0.057	milli-in	
30	11	Absolute Displacement - Channel 11	0.000	0.000	milli-in	
31	Ch9 - Ch8	Relative Displacement (Ch 9 - Ch8)	0.186	-0.203	milli-in	
32						

Figure 48: Dynamic Excitation Template Summary Table

31. **Fill in** the title, date, and description fields at the top of the table for the event.

32. Add a **description** for each channel in the corresponding fields.

****Note:** The template is fully completed. Unless further changes are desired, continue to steps 33 a-c to print the outputs or 33 d-f to export the outputs to a word processing document.

33. Printing or Moving Outputs.

- a. Select the tab to be printed.
- b. Go to File and select Print.
- c. Make sure Print Active Sheets and the correct printer are selected and click print.

OR

- d. Select the group of plots or the table, right click, and select copy.
- e. Open Microsoft Word or another word processing program.
- f. Right Click and Select Paste.

****Note: Sample Outputs** of the plots and the summary table can be viewed in the **Reports** section of the User manual.

Generating Output Reports

Objective

Data collected from the EchoPro recorder must be presented in a graphical manner that is both coherent and simple to be able to emphasize the areas of importance. The excel templates discussed in the user manual and Appendix I generate output graphs and tables that can serve as the backbone of a report. This section will discuss the important considerations of reporting on the data and show the correct tables and plots created from both the long term and dynamic excitation templates sample data

Report Considerations

Writing a report on a deployment period or an event is vital to communicating and explaining crack response. Important considerations of these reports include: general deployment information, sensor information, event information, and formatting.

The general information should consist of the purpose of deployment, the time period, the location of the system and its relative location to important external activities, and the individuals or organizations monitoring the system. This information should be incorporated early on to provide the general context of the data collected.

Information about the sensors should be detailed as thoroughly as possible in the report prior to discussing the results. This should involve sensor orientation, sensor type, sensor location, and what is being monitored. The channel number and serial number can help organize these facts. A figure or figures should be employed to visually describe the location of the sensors within the test site.

Before illustrating the output tables or plots from the excel templates, the event or recording should be described. This description should include the event type (long term or burst event), event data and time, what triggered the system (if applicable), and as much additional detail as possible. After this is complete, the summary table and selected graphs should be added to highlight the results of the event.

Formatting of a report is significant in helping to communicate effectively the ideas within. This includes section headings, graph and table titles, and consistent fonts and line spacing. The headings are important to divide the report up for the reader and the graph and table titles help to clarify the context of the output data.

Long Term Template Outputs

The long term template automatically generates a summary table and plots within Microsoft Excel.

Table 1 is an example from the long term template. The top cells provide spaces to include a table name, the recording period, and descriptions of the data collected. The descriptions of each sensor should be modified to be as specific as possible, especially in regard to sensor location. The table displays the maximum and minimum ranges of the data as well as the units for these values. The table aggregates data collected from both the EchoPro recorder and the SUPCO temperature and humidity loggers

Figure 49 is an example of one of the plots that can be produced automatically. The channels plotted and their scaling can be adjusted within the template. Depending on the report, all the plots may be included or only specific ones may be necessary. Specific plots can be chosen based on the type of event and the response of each sensor.

Table 1: Sample Long Term Output Table

Long Term Sample Data		Sample Long Term Data to Check the Process Outlined by the User Manual		
4/13/11 - 4/17/11				
Kelunji EchoPro				
Channel	Description	Maximum	Minimum	Unit
1	Response - Crack 1	360	-637	μ-in
2	Response - Crack 2	868	-781	μ-in
3	Response - Crack 3	24	-36	μ-in
4	Response - Crack 4	146	-266	μ-in
5	Response - Crack 5	200	-210	μ-in
6	Response - Crack 6	81	-115	μ-in
Interior SUPCO Temperature and Humidity Logger				
Channel	Description	Maximum	Minimum	Unit
Temp	Interior Temperature	72.430	66.080	°F
Hum	Interior Humidity	43.500	34.400	%
Exterior SUPCO Temperature and Humidity Logger				
Channel	Description	Maximum	Minimum	Unit
Temp	External Temperature	71.222	33.494	°F
Hum	External Humidity	98.886	29.989	%

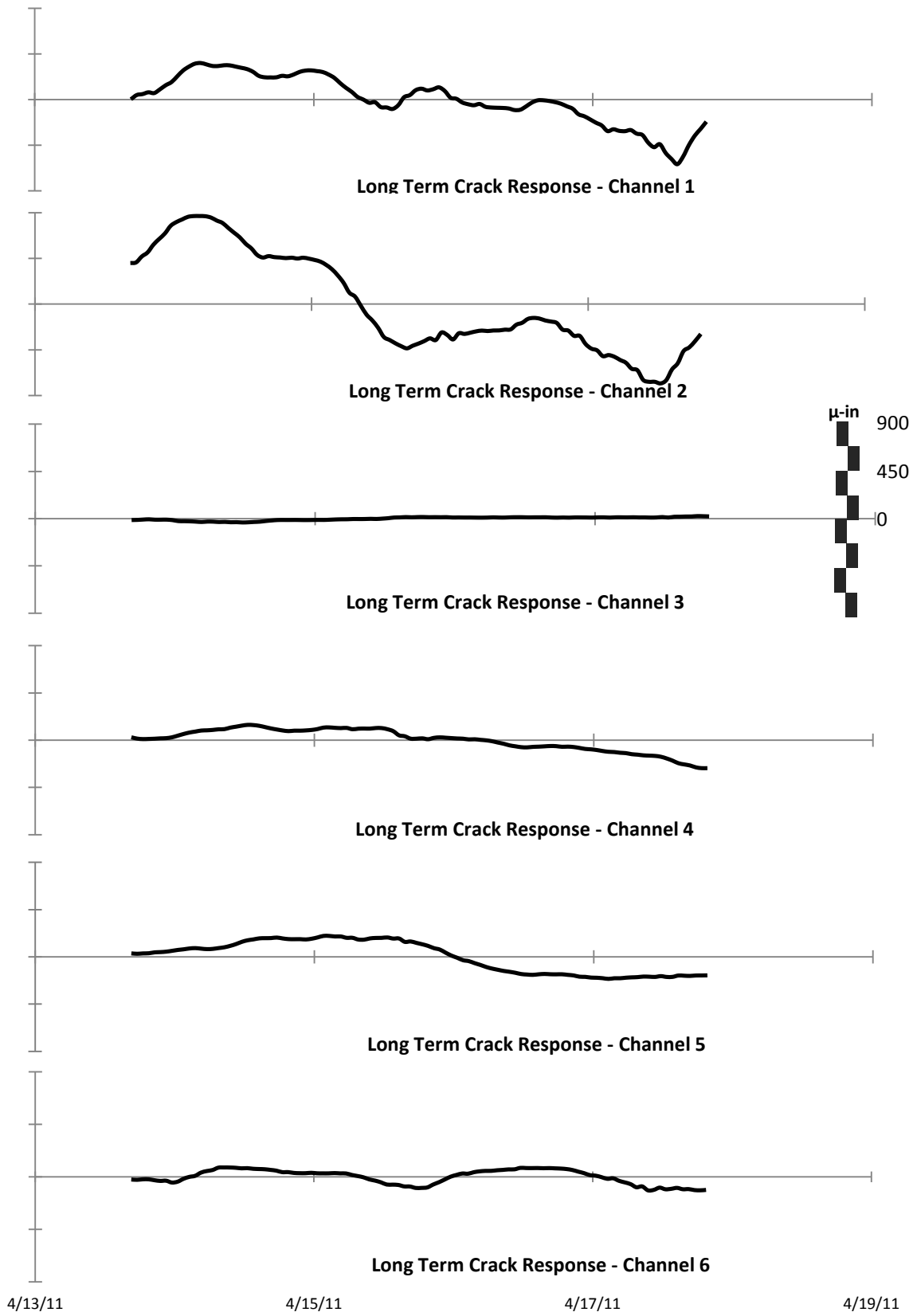

Figure 49: Sample Long Term Crack Movements from template Sample Data Set – Tab 2

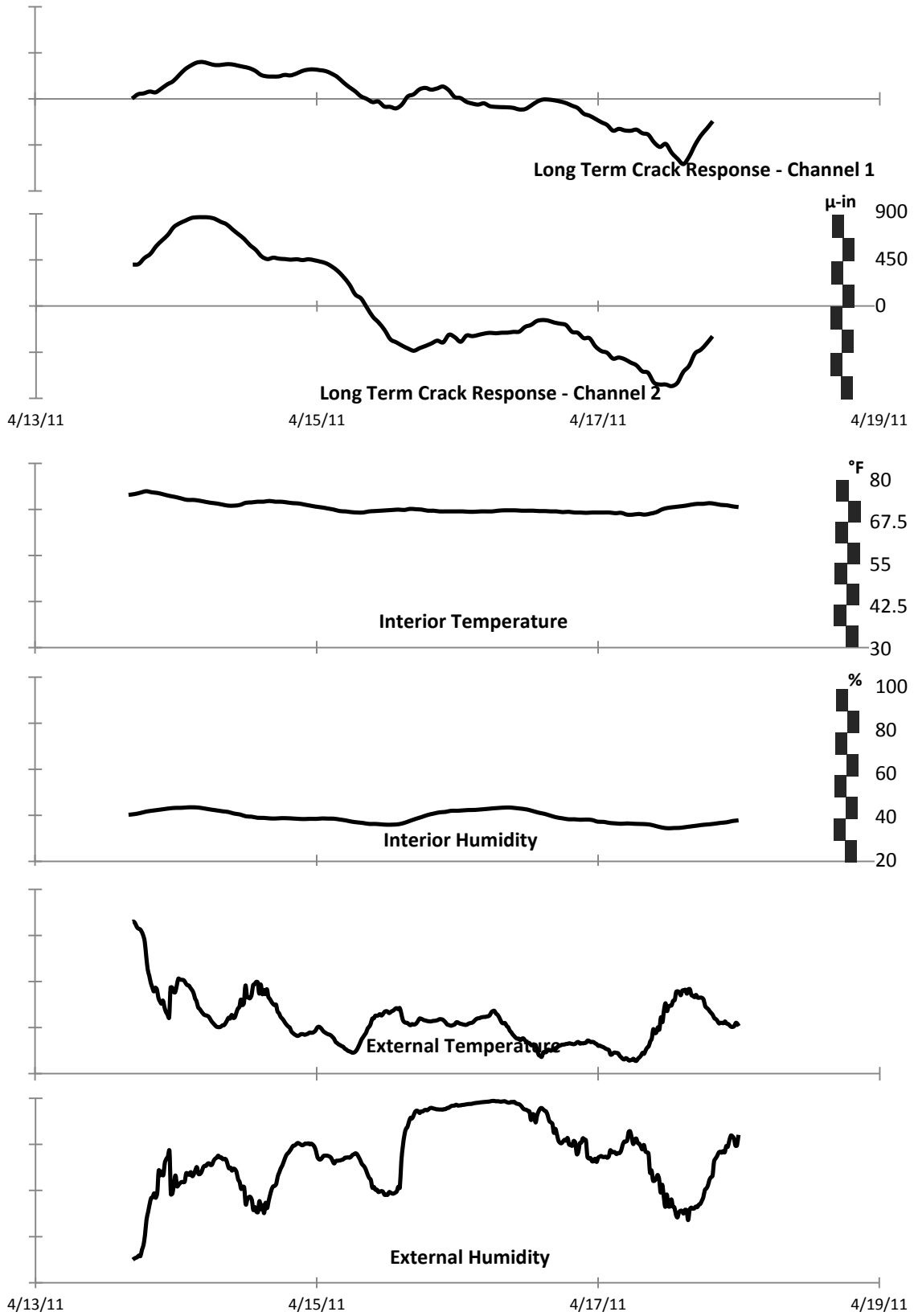

Figure 50: Long Term Crack Movements with SUPCO Data from Template Sample Data Set – Tab 4

Dynamic Excitation Template Outputs

Similar to the long term template outputs, the dynamic excitation template automatically generates a summary table and plots. Table 2 is an example of the completed table. The table aggregates data collected from both the EchoPro recorder and the LARCOR compliance seismograph.

Figure 51 is an example of one of the plots that can be produced automatically. As with the long term template, the channels plotted and their scaling can be adjusted within the template and the plots selected should be based on the report type, the event type, and the response of each channel.

Table 2: Sample Dynamic Excitation Output Table

Dynamic Excitation Sample Data		Sample Dynamic Excitation Data to Check the Process Outlined by the User Manual		
April 20th 2011 09:53				
Kelunji EchoPro				
Channel	Description	Maximum	Minimum	Unit
1	Crack Response - Channel 1	425	-228	μ-in
2	Crack Response - Channel 2	702	-971	μ-in
3	Crack Response - Channel 3	7	-11	μ-in
4	Crack Response - Channel 4	126	-174	μ-in
5	Crack Response - Channel 5	157	-327	μ-in
6	Crack Response - Channel 6	187	-274	μ-in
7	Structural Response - Channel 7	1.64	-1.36	in/s
8	Structural Response - Channel 8	0.43	-0.48	in/s
9	Structural Response - Channel 9	0.94	-0.71	in/s
10	Structural Response - Channel 10	0.58	-0.74	in/s
11	Structural Response - Channel 11	0.00	0.00	in/s
12	Trigger Signal - Channel 12	5.03	0.00	Volts
LARCOR Seismograph				
Channel	Description	Maximum	Minimum	Unit
A	Air Blast	112	0	Decibels
R	Radial Ground Motion	2.12	-1.82	in/s
V	Vertical Ground Motion	2.48	-1.86	in/s
T	Transverse Ground Motion	2.8	-2.72	in/s
Displacement				
Channel	Description	Maximum	Minimum	Unit
7	Absolute Displacement - Channel 7	0.175	-0.219	milli-in
8	Absolute Displacement - Channel 8	0.091	-0.072	milli-in
9	Absolute Displacement - Channel 9	0.140	-0.141	milli-in
10	Absolute Displacement - Channel 10	0.053	-0.057	milli-in
11	Absolute Displacement - Channel 11	0.000	0.000	milli-in
Ch9 - Ch8	Relative Displacement (Ch 9 - Ch8)	0.186	-0.203	milli-in

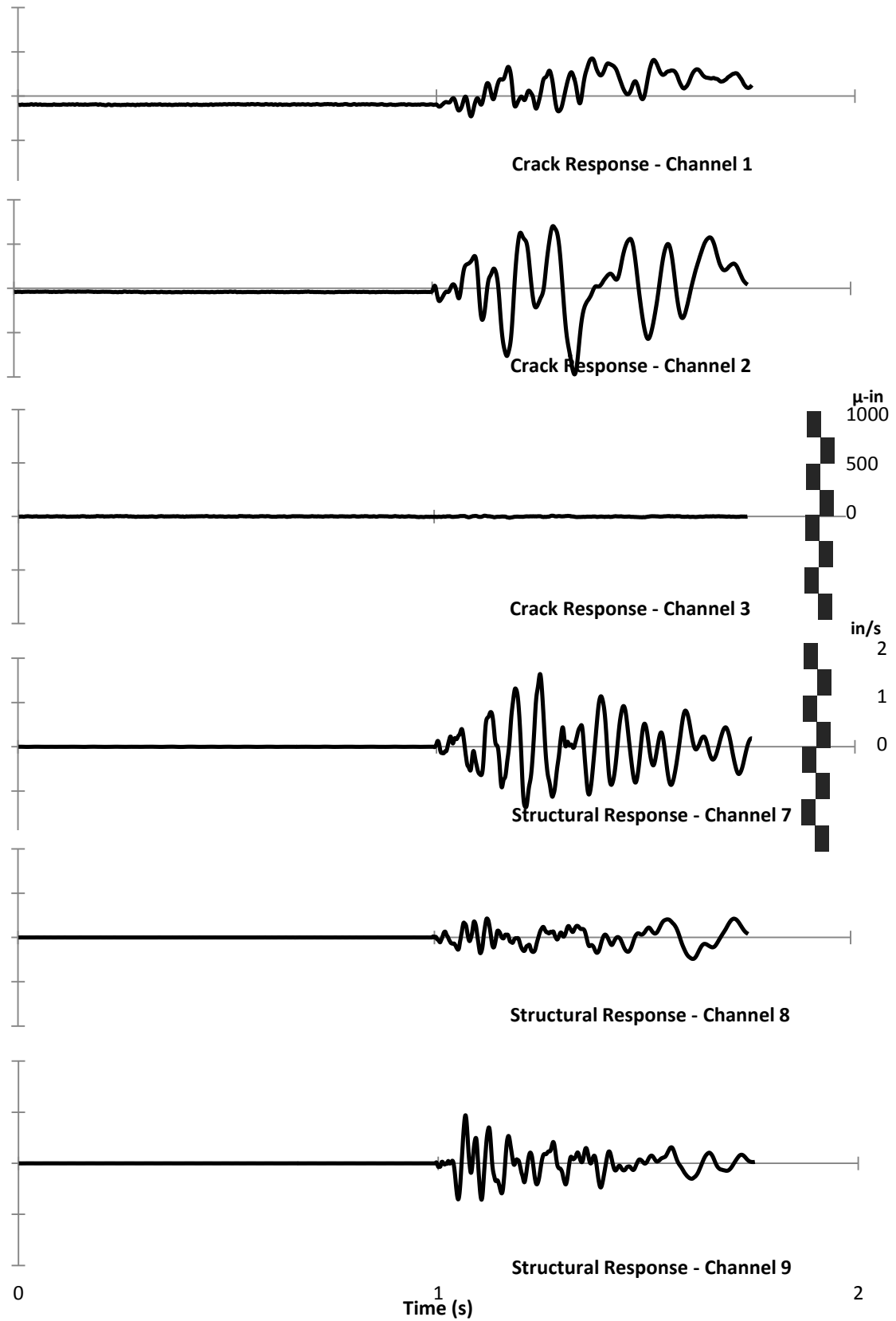

Figure 51: Sample Dynamic Excitation Data – Tab 3

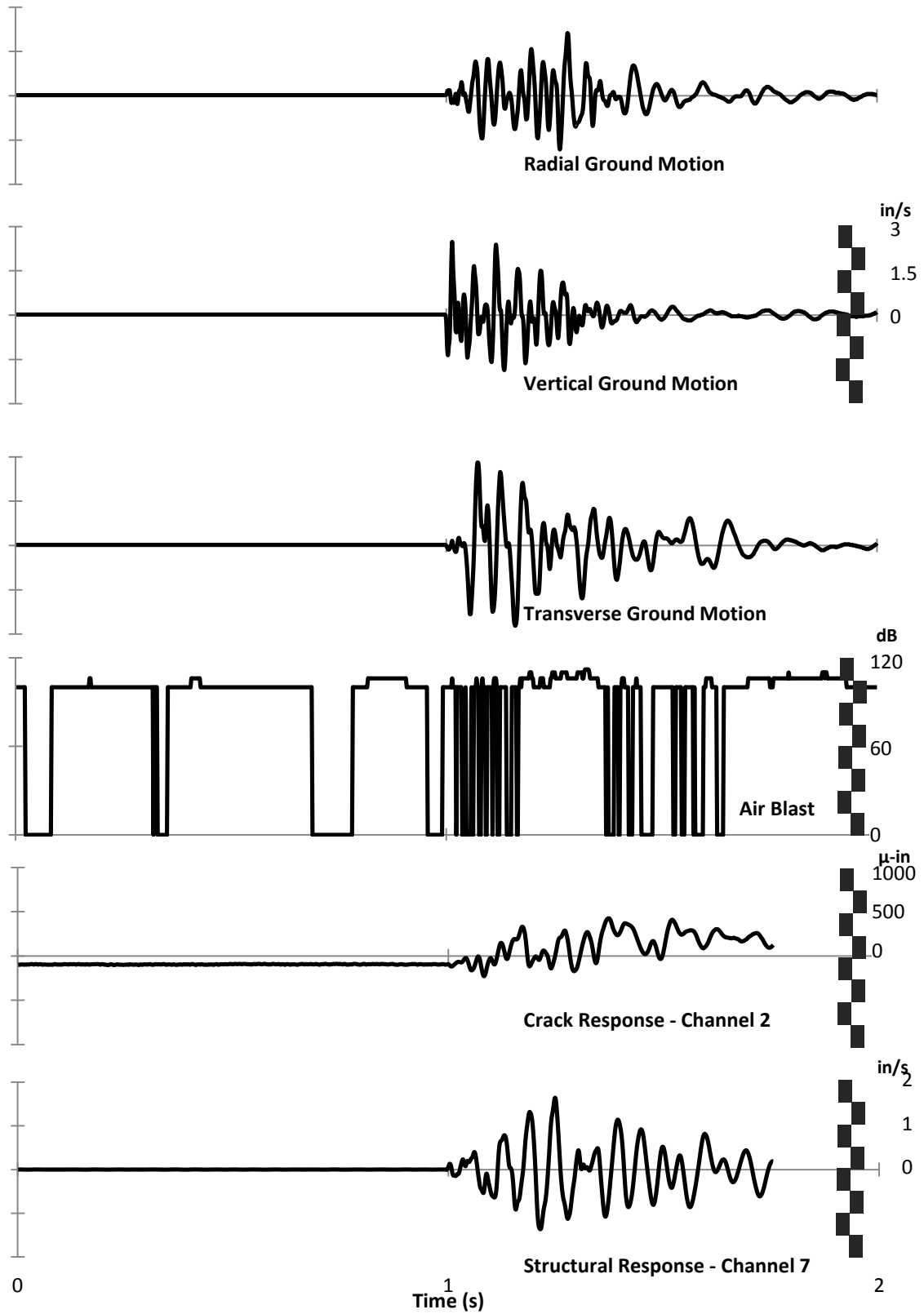

Figure 52: Sample Dynamic Excitation Plots - Tab 4

Appendices

Appendix A - Kelunji EchoPro Recording Unit

Objective

This appendix describes the configuration of the Kelunji EchoPro unit to measure crack and structural response. Operating instructions and technical descriptions can be found in the Kelunji user manual, which can be obtained from the following link:

<http://customer.esands.com/index.php?section=45>

Setup

In order to configure the EchoPro recording system to monitor long term and dynamic data, the unit must be programmed for the proper sampling rate and processes, and have a large source of data storage.

-Sampling

The EchoPro records all of its processes with the same underlying sample rate. For dynamic events, it is important that the sample rate be set as high as possible for the highest detail of the event. Therefore, 1000 Hz (samples per second, sps) is the recommended sampling rate for the recorder. This rate will ensure that any reasonable triggered recording will be precisely recorded. While 2000 sps is possible, 1000 sps has been chosen at this time because of data recording constraints.

-Processes

To setup the EchoPro to monitor various types of data, different recording processes can be established. For the long term crack data, the continuous recording process should be enabled and set to measure only channels with connected LVDTs (channels 1-6). Dynamic events require a trigger or threshold level recording process. A triggered process requires that each channel (typically geophone

channels) serving as a trigger must be selected and given a specific level that will cause the system to record. Also, this process should record the response of all sensors attached to the EchoPro. Finally, if an external trigger is utilized (such as the LARCOR compliance seismograph); a second level recording process should be created. It will be set to trigger only from the external trigger channel and must record all sensor channels. More information on setting trigger levels is described in Appendix G.

-Data Storage

Because of the large volume of data being stored at the units sampling rate of 1000 sps, it is necessary to employ a high capacity internal storage device. A thumb drive with at least 64 GB of storage will be required for autonomous monitoring of six continuously recorded channels at 1000 Hz. This assumes that the continuous data will dominate the space required for the burst or triggered events. However, a very active test site may require a larger storage device. While certain external hard drives can function with the EchoPro unit, it is difficult to ascertain the compatibility of a drive without testing it with the Kelunji.

-Technical Changes

To improve the feasibility of the unit for crack monitoring, the unit was configured by its manufacturer to provide a 24V power pin in its sensor ports A and B. This setup is assumed for the wiring of the connector boxes and the use of LVDTs with the system (which require an external power source).

-Port Details

The following diagrams and photographs show the technical details of the Kelunji ports and their pinout descriptions.

Sensor Ports

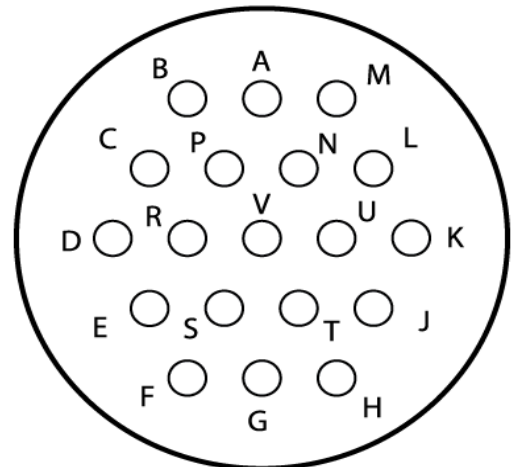

Figure A 1: Kelunji EchoPro External Sensor Ports

EchoPro sensor port connector

Below is a diagram of the pin connections of the standard EchoPro input ports. Looking at the back of the supplied sensor connector shows the same pin configuration. The function of Each pin is listed below.

A n/c (24 V power pin on A&B – specially altered unit)
 B GROUND (battery ground)
 C X Signal
 D X Return
 E Y Signal
 F Y Return
 G Z Signal
 H Z Return
 J Voltage Calibrate Signal
 K Voltage Calibrate Ground (same as pin B)
 L n/c (not connected)
 M POWER (battery voltage)
 N n/c
 P n/c
 R n/c
 S n/c
 T Current Calibrate Signal
 U Current Calibrate Return / Calibrate Enable
 V SHIELD



MS3116F14-19P
 (rear view)

Figure A 2: EchoPro Port Pinout

Appendix B - Connector Boxes

Objective

The Kelunji connector box allows for the use of sensors that cannot directly interface with the Kelunji EchoPro. Because each of the four ports on the EchoPro can process three distinct input channels, the box must also be able to connect three sensors to one input cable. Due to the differences in sensor power requirements, two different units must be constructed, powered and unpowered.

As shown in Figure A 3, the powered connector box will transmit power from the EchoPro ports A and B to the appropriate sensors and transmit sensor output to the Kelunji to be recorded. The unpowered connector box connects the sensor outputs to the EchoPro ports C and D but does not provide power. Unpowered ports can service velocity gauges, which do not require power.

Equipment

The required equipment to construct the connector boxes includes: two aluminum casings, twelve Female Turck bulkhead connectors, and four bayonet cables

The aluminum case for the connector box measures six inches by four inches by three inches (L, W, and H) and includes a removable cover with four corner screws. This case serves to house and protect the electronics for the connection. The female Turck bulkhead connectors (nCode Part SO-J-MFK6F-CS10343), serve as ports to connect the twelve sensor channels to the Kelunji EchoPro via the final constructed equipment. The four bayonet cables have a free end that is secured within the connector box and a wired bayonet connection to plug into the four EchoPro ports.

Construction

The construction of the connector box can be divided into four key categories: drilling, wiring, sealing, and labeling.

-Drilling

Drilling holes for the connector box is the essential first step. Each box requires six holes for the female Turck PicoFast ports on one side and two larger holes for the bayonet connections on the other. As shown in the diagram below, the six holes for the channel ports are arranged in two triangular formations to make best use of the space.

First, the diameter of both the channel ports and the bayonet connector must be measured with a caliper. The holes need to be drilled just larger than these measurements to help provide a snug fit. The connector box can be drilled using a drill press or other equipment. Once these holes are created, the connector boxes should be sanded, cleaned, and should be checked for fits with the cables and connectors.

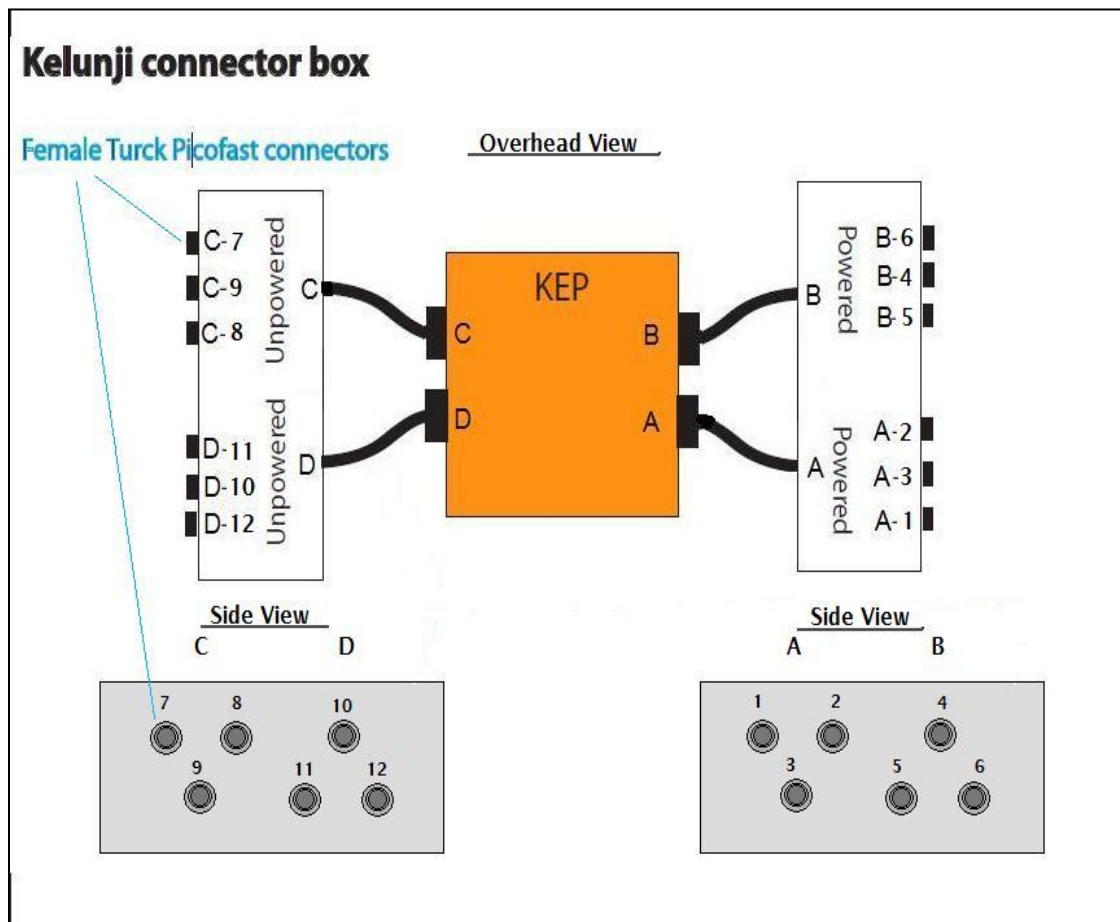

Figure A 3: Kelunji Connector Box Diagram

-Wiring

In order to wire each connector box, the two wiring diagrams at the end of this document are essential. Interior wiring is illustrated in Figure A 4. For the powered box, the power, power ground, shield, signal ground, and signal leads must be connected. For the unpowered box, only the signal, signal ground, and shield leads need to be connected.

First, the leads from the female Turck Picofast port must be soldered to the corresponding leads on the bayonet cable, which must be in the connector box during this process. Each lead should be protected with heat shrink tubing. The power and ground leads must be split to three ways from the bayonet cable to each of the three port channels.

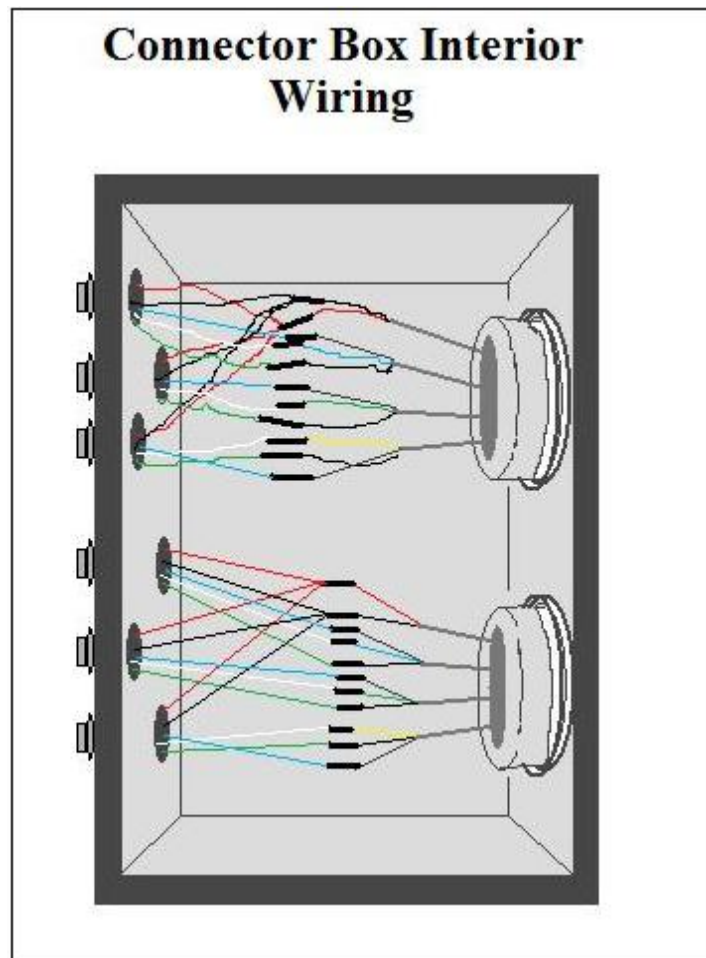

Figure A 4: Connector Box Interior Diagram

-Sealing

The process protects the connector box wiring for use in an indoor instrumentation environment. It is outlined below.

Turck Picofast Connectors (6 signal ports – shown in Figure A 5)

- Place female Connector Ports into holes from the inside
- Screw connecting nuts onto outside of ports
- Tighten to snug fit

Bayonet Connectors (2 large cables – shown in Figure A 6)

- Place Bayonet Connector Cable into ports from outside.
- Screw down plastic nut on inside of connector box
- Tighten to snug fit
- Ensure rubber ring complete seal on box
- Tighten top plate onto connector box

- Labeling

Labeling ensures that the connector boxes and channel ports are easy to identify in the field. The powered box needs to have its channels (1-6) and the bayonet cables (A and B) labeled. The unpowered box will be labeled for channels (7-12) and bayonet cables (C and D). Additionally, each box can have a label identifying whether it is a powered or unpowered setup. The photographs below show the final construction of a connector box with labeling.



Figure A 6: Labeled Connector Box - Bayonet Cable Side



Figure A 5: Labeled Connector Box - Turck Picofast Connector Side

Kelunji connector box wiring

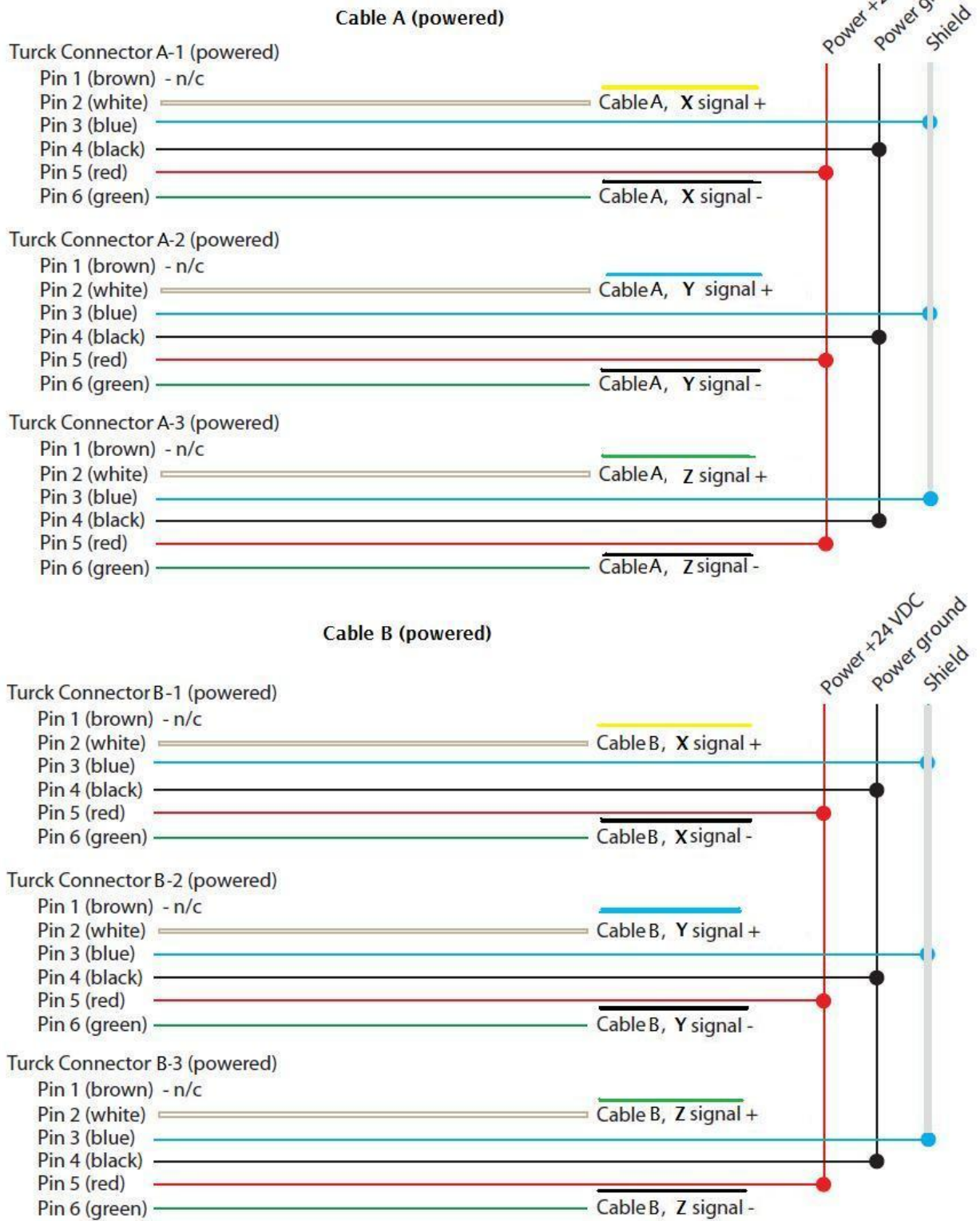

Figure A 7: Powered Connector Box Wiring Diagram

Kelunji connector box wiring

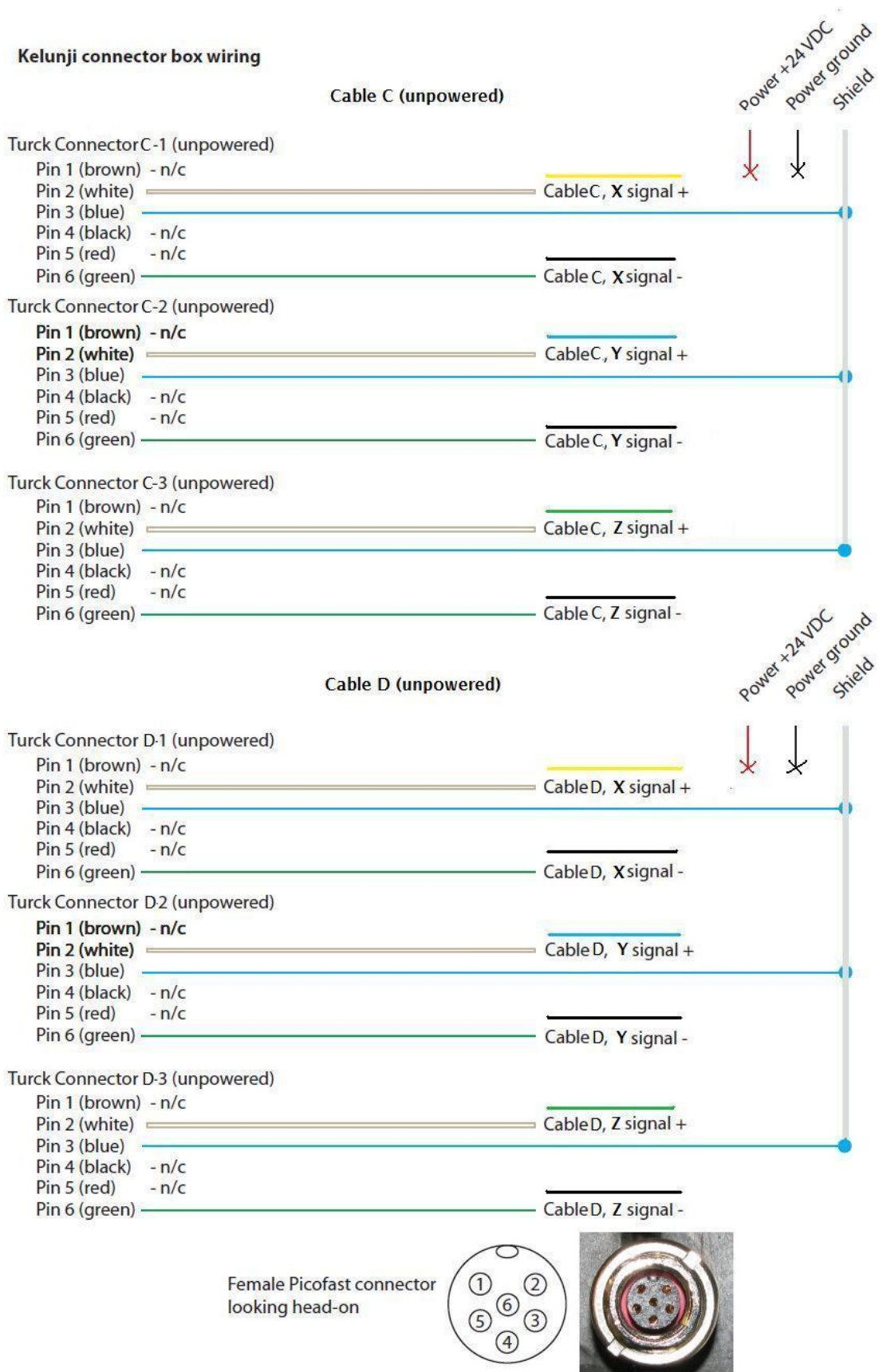

Figure A 8: Unpowered Connector Box Wiring Diagram

Appendix C - Geophones

Objective

A Geophone is an instrument that allows for the measurement of velocity at the point where it is mounted. The products are designed to measure one of two primary orientations, horizontal or vertical. For this project, geophones are employed to measure the structural response to dynamic events.

Technical Description

The HS1 model geophones, produced by the company Geospace, do not require a power supply, are relatively compact, and can be ordered with low natural frequencies. This model was chosen because of its usefulness for accurately measuring low frequency dynamic motion for structures. The output of the geophone is an electrical signal in volts that represents the response at a given location and time. The conversion factor into engineering units for an undamped sensor is 1.15 V per inch per second. However, the following graph shows how the conversion factors are modified for damping and frequency. More technical information can be found at the Geospace website.

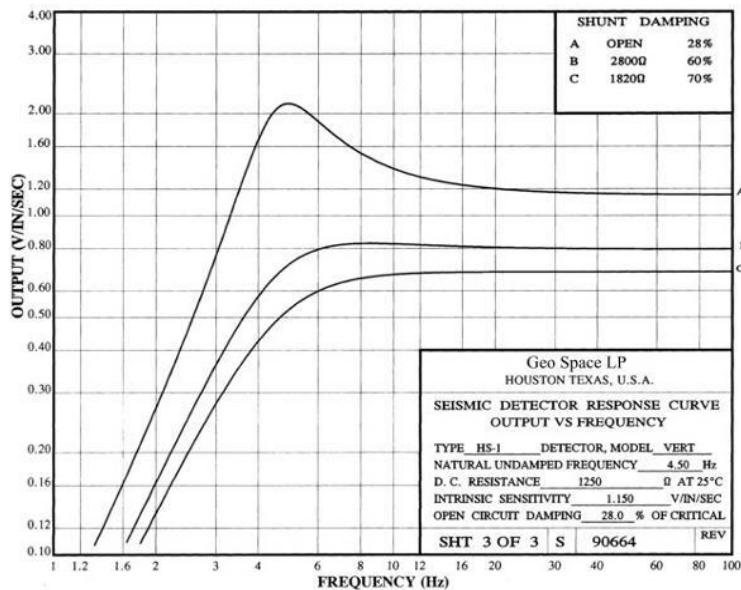

Figure A 9: Output Voltage vs. Frequency for Damping Values

Geophone Preparation

In order to prepare the HS1 model geophones for deployment, four major steps are necessary.

1. The sensor needs to be prepared for the correct level of damping (70%). First, the existing connection wire between the nodes needs to be cut and removed. Then, using a 1960 Ohm resistor, reconnect the nodes. This can be achieved by twisting the wires on each side around the nodes two or three times and trimming the excess. These wires should then be soldered onto the nodes. To test this connection, the resistance across the nodes can be checked with a multimeter. The correct reading should be around 760 Ohms.
2. The second step is to solder the geophone to the signal wire through the two output nodes. The geophone is marked with a plus (+), marking which output node carries the response signal. The wires are soldered vertically to both the resistor and the output node and protected by heat shrink tubing. The correct wiring is shown in the diagram below. The heat shrink tubing should cover each individual node and a larger tube to protect the entire connection. The proper preparation of the geophone should be determined with a multimeter for the resistance between the signal wires (with the same result as above).

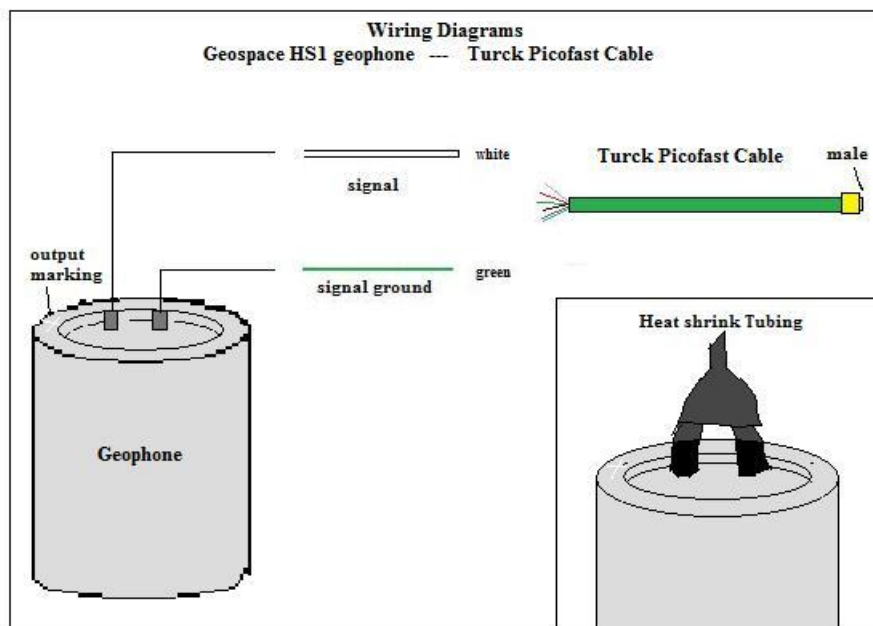

Figure A 10: Geophone Wiring Diagram

3. A bracket must be constructed to anchor the sensor in the field in the desired orientation. First, aluminum plating 3" wide and 3/8" thick must be cut with a horizontal bandsaw at a length of 4 inches. Then a 1/2" hole must be made with a drill press or other method through the center of the square face. This hole must then be tapped to a one-half inch thread with 20 threads per inch.

The diagram below shows the end result. If the geophone is to be mounted vertically from a ceiling, it must be secured with screws. To do this, holes should be drilled in the corner of the bracket, just larger than that of the screws. Then, the top of this hole needs to be countersunk just larger than the head of the screw. A geophone attached by this method is shown below.



Figure A 11: Finished Geophone with Drilled Bracket

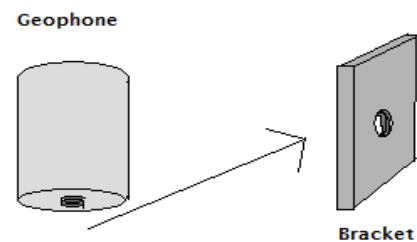

Figure A 12: Geophone & Bracket

4. The final step is to provide strain relief for the soldered connections so that disturbances in the field will not damage the sensor or its ability to transmit data. This is achieved by placing the signal wire through a snugly fitting plastic wire holder. Then, this wire holder is fastened and tightened directly to the top of the geophone with a 6/32" screw. The strain relief and the sensor preparation should be demonstrated in the photograph below.

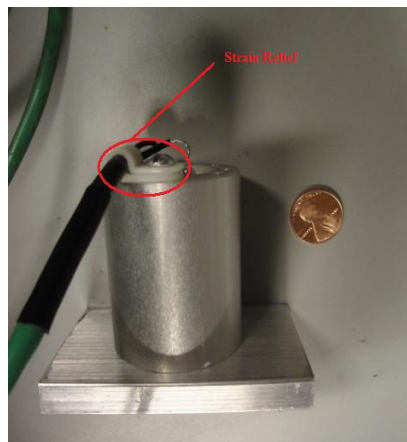

Figure A 13: Geophone Strain Relief

Appendix D - LVDT's

Objective

The LVDT (Linear variable differential transformer) is a transducer that records displacements over time. For crack monitoring purposes, the MacroSensor SE 750-100 series was selected for its accuracy at very small displacements as well as input and output voltages that are feasible with the Kelunji EchoPro Recording System.

Technical Description

The sensor requires 24 volts DC input power and sends a zero to ten volt output to the recorder. This sensor has a nominal range of one tenth of an inch, which allows for precise measurements of crack movements relative to the output resolution and the associated noise level (discussed in Noise Comparison). The output is an electrical signal that varies between 0 and 10 volts, converted to engineering units by the factor 100 V/in. Figure A 14 outlines some of the pertinent technical details. For more information, view the LVDT specification at the MacroSensor website.

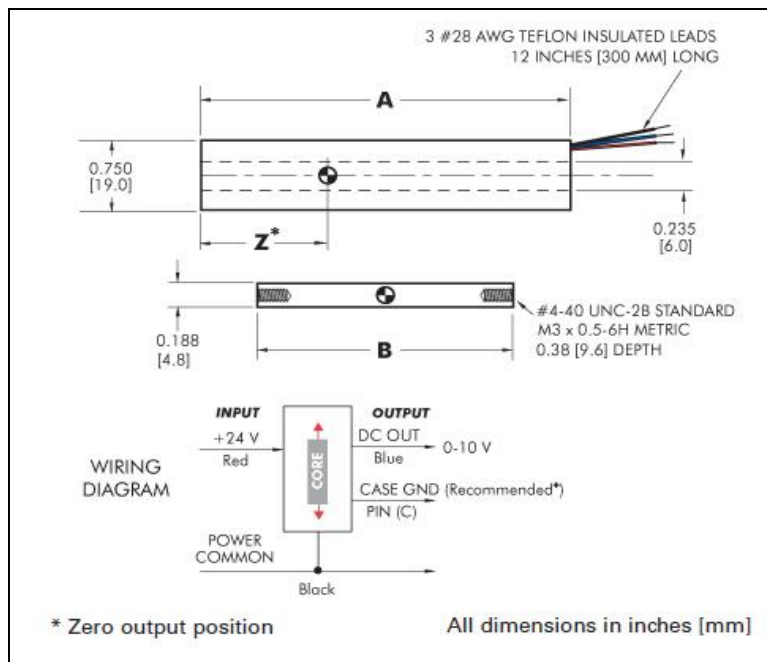

Figure A 14: LVDT Technical Information

Sensor Preparation

In order to prepare the LVDTs for use, five main processes have to be completed.

1. The sensor's signal, ground, and power leads need to be soldered to a male Turck Picofast cable, with heat shrink tubing for protection as shown in the wiring diagram in Figure A 15. The first step is to cut a short cable near the female connector and use the remaining cable (male end and free end) to connect with the LVDT. The second step is to strip away three to six inches of the exterior shield from the free end to expose the leads. Then, the corresponding leads of both the cable and the LVDT need to be soldered according to the wiring diagram below. Make sure to protect these soldered connections with heat shrink tubing (over both the solder joints and the open wire between the LVDT and the cable)

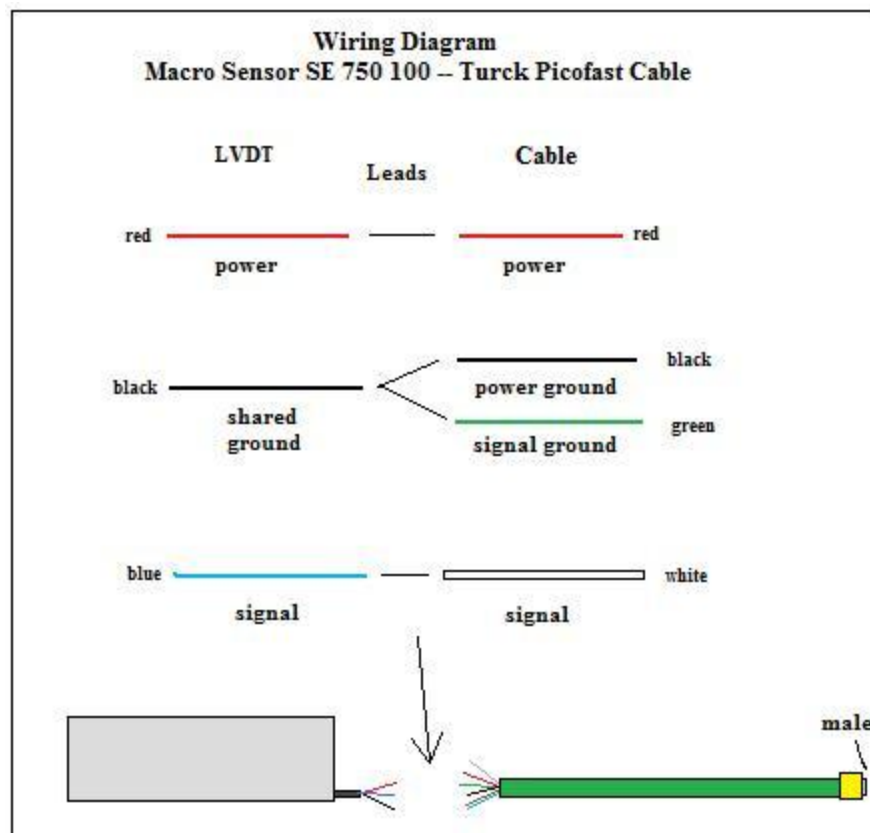

Figure A 15: LVDT Wiring Diagram

2. The body of the transducer has to be epoxied into a 1" by 1" square aluminum casing that will protect the sensor as well as facilitate the mounting process. To do this, cut a length of aluminum tube with a horizontal bandsaw to the length of the LVDT. The interior thickness must be filed slightly until the LVDT body just fits into the tube. Then, the rough edge should be sanded and the aluminum casing

cleaned. With the tube and LVDT ready, prepare one minute epoxy and apply to the top, bottom, and sides of the LVDT and slide it into the tubing. Ensure the front (sensing) face of the LVDT is aligned with the casing and clean up any excess epoxy.

3. The target bracket needs to be constructed from 1"x1" L-shaped aluminum tubing, a 4/40" screw, two 4/40" bolts, two #4 washers, and the LVDT core as shown in Figure A 16. This bracket serves to hold the LVDT target in place on the opposite side of the crack being monitored. The first step is to cut an appropriate bracket from aluminum "L" tubing on a horizontal bandsaw. A good approximation is to cut a bracket the same length as the width of the LVDT casing (1"). Then, the target position must be determined by precisely measuring the height to the center of the LVDT from the exterior tubing. This will ensure that the target will be aligned accurately with the LVDT. Using a drill press or other equipment bore a hole through this location that is larger than the 4/40" screws but smaller than the bolt and washer diameters. This bracket should be sanded and cleaned once it is machined. Next, a screw must be mounted to the bracket with 4/40" nuts and #4 washers on both sides.

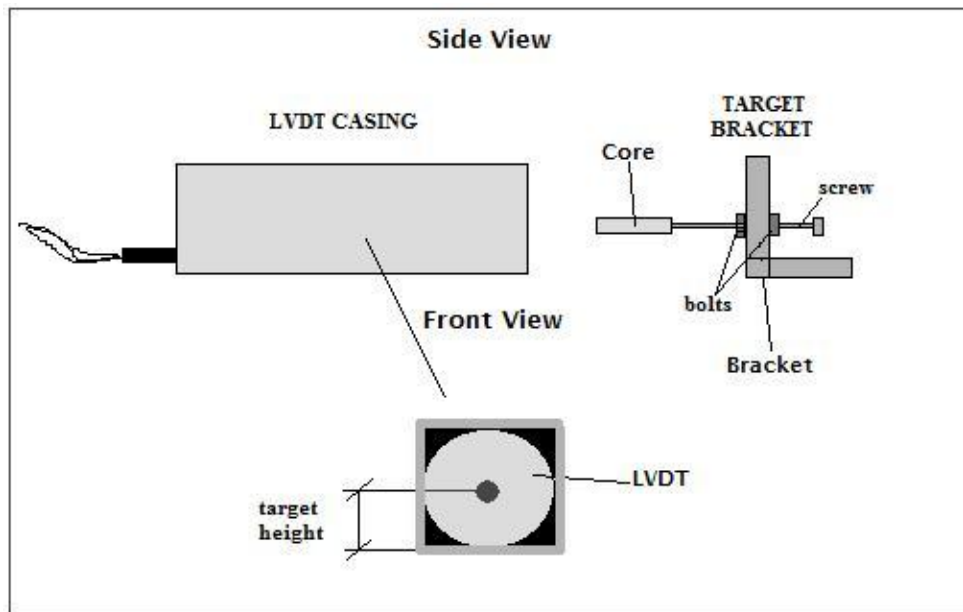

Figure A 16: LVDT Construction Diagram

4. The core of the LVDT needs to be attached to the bracket. First, the core is twisted onto the screw until about half of the core is threaded. Then, thread-locker must be applied to the screw and the

core moved over it. This will prevent future movement of the component, which is necessary for accurate measurements.

5. The LVDT needs strain relief to prevent damage to the sensor or the solder connection while in the field. First, a small hole must be drilled in the top right corner of the LVDT's aluminum casing, large enough for a small cable tie. Then, the LVDT connection must be bent onto the top of the casing and secured with a cable tie. This is shown in Figure A 17.



Figure A 17: LVDT Strain Relief

Appendix E - Temperature & Humidity Logger

Objective

The SUPCO temperature & humidity logger is used to measure the long term changes of these variables inside the test house. Combining this data with the long term crack response can show the correlation between temperature, humidity, and crack movement. Technical descriptions and further operating instructions can be found from the website or the software's help menu.

Logger Preparation

Place 9V Battery into Data Logger.

If necessary, install "LOGiTpcInterface" with installation disk

Open Program "LOGiTpcInterface"

From Software's Help Menu

To set the LOGiT logger to start recording data, select **Setup** from the **Logger** menu. The setup options window is shown below.

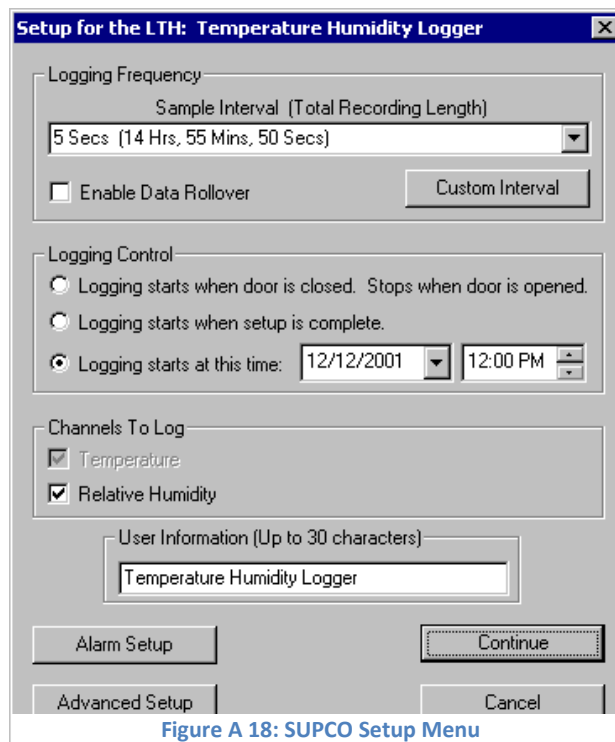

Figure A 18: SUPCO Setup Menu

Sample Interval (Total Recording Length): Select the sample interval from a predefined list of intervals.

The sample interval greatly affects the battery life of the logger.

- **Custom Interval:** Adds your own interval to the sample interval list.
- **Enable [Data Rollover](#):** Check this box to have the logger continuously record the data, overwriting earliest recorded data. When this box is not checked, logging is stopped when the logger memory becomes full.
- **Logging Control:** Logging can start in three ways depending on the selection you make:
 1. **Logging Starts When Door Is Closed, Stops When Door is Opened:** Logging will not start until the sliding door is closed. Logging is stopped when the sliding door is opened. This mode does not allow real time monitoring of data. Logging must be stopped before the data can be retrieved. When the sliding door is opened the logger will flash the LED for 10 seconds, if the door is closed again during this interval, the logging will not stop.
 2. **Logging Starts When Setup is Complete:** Logging will start immediately once the **Continue** button is pressed, and OK is clicked on the follow-up warning message. When logging is started in this way, the sliding door does not have any effect on logging, but can still be used to secure the logger.
 3. **Logging Starts At This Time:** Logging will start at the user specified time. There is no limit how far in the future you can set the logging to start. When logging is started in this way, the sliding door does not have any effect on logging, but can still be used to secure the logger.
- **Channels to Log:** You can elect to disable unused logger channels. When a channel is disabled, its memory is allocated to the other channels, increasing the total logging time. The total logging time will be reflected in the **Sample Interval** window. Depending on the logger, some channels are required and cannot be disabled. At least one channel must be enabled for logging.
- **User Information:** Enter any text you like in this box. This field is used to identify the logger to the user. You can enter descriptive location, serial number, etc.
- **Alarm Setup:** Click this button to open the **Alarm Setup Window**.

Data Retrieval

-Exporting SUPCO Temperature/Humidity Data to Excel

From Software's Help Menu

The LOGiTpc software allows exporting sample, alarm and logging summary data to a text file. In addition, sample data can be exported to a Microsoft Excel file.

- To export sample, alarm and logging summary data to a text file, from the **File** menu select **Export -> Text File**.
- To export sample data to a Microsoft Excel file, from the **File** menu select **Export -> Excel File**.

The file exported to Microsoft Excel is a text file that Excel understands. To read the file into Microsoft Excel, follow these steps:

- From the Microsoft Excel application choose **Open...** from the **File** menu.
- In the *Open* window, under *Files of type*: select *Text Files*.
- Select the file you exported from the LOGiTpc program.
- **When the *Text Import Wizard* window opens, just click the *Finish* button.**

Appendix F - LARCOR – Kelunji Serial Splitter

Objective

A serial splitter was constructed to allow an external trigger pulse from the LARCOR compliance seismograph to activate a recording process on the EchoPro unit. This splitter combines the function of a normal serial splitter with a soldered Turck Picofast cable that can communicate with the Kelunji EchoPro via a connector box.

Cable Wiring

To construct the serial cable, the information outlined in Figure A 20 is vital. As stated, pins 5 (ground) and 9 (trigger output) as utilized by the LARCOR unit are essential to communicating a trigger pulse. As the wiring diagram shows, pin 5 (yellow lead) must be soldered to the green lead (signal ground) from a Turck Picofast cable with a free end and a male connector. Pin 9 (grey lead) must be soldered to the white lead (signal) from the same Turck Picofast cable. These are the only two pins necessary to the communication. If pins 1 and 4 were connected, they would freeze the trigger pulse at 5V and prevent the correct operation of this triggering process. Figure A 19 shows the assembly of the splitter cable and other cables.

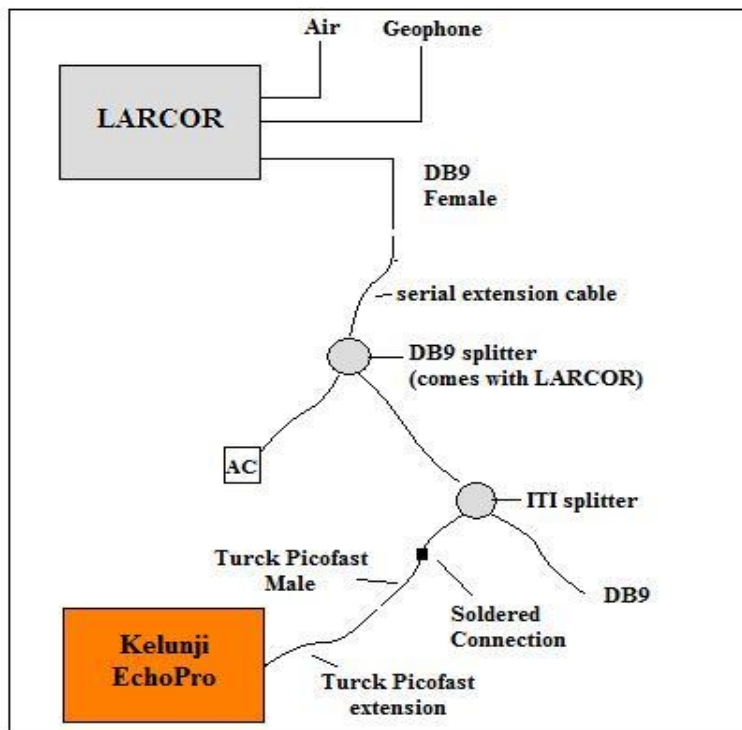
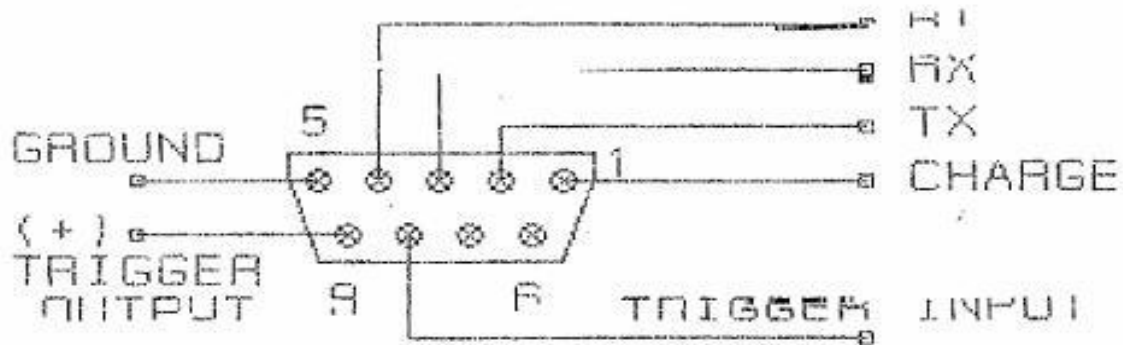

Figure A 19: LARCOR to Kelunji EchoPro Connection Diagram

TRIGGER1.CSC

EXT TRIGGER OUTPUT
PART 1 OF 1

PINS 5 & 9 USED TO TRIGGER
AN EXTERNAL DEVICE.



REAR VIEW OF MALE PLUG WHICH
CONNECTS TO THE RS232 CONNECTOR.

Pin
1 Black
2 Brown
3 Red
4 Orange
5 Yellow
6 Green
7 Blue
8 Violet
9 Grey

Male DB-9

1 Black	→	Black
2 Brown	→	Brown
3 Red	→	Red
4 Orange	→	Orange
5 Yellow	→	Yellow
6 Green	→	Green
7 Blue	→	Blue
8 Violet	→	Violet
9 Grey	→	Grey

Female DB-9

Do not connect pins 1 & 4

Trigger will freeze at 5V

Green
White
Turck Picofast Cable
(Male)

Figure A 20: LARCOR – Kelunji EchoPro Serial Splitter Wiring Diagram and Pinout

Appendix G - Setting Trigger Levels

Objective

The Kelunji EchoPro system can monitor dynamic events effectively through the use of certain trigger levels or thresholds. This allows for memory conservation and facilitates identification of key events. These triggers can occur from sensors directly connected into the EchoPro or from a separate monitoring system (such as the LARCOR compliance seismograph).

Appropriate Levels

Setting appropriate trigger levels is vital to the proper operation of a triggered recording process. If the threshold level is too low, the device will be inundated with useless triggered recordings that will effectively bury the important dynamic recording and fill up the device's storage capacity. However, if the level is set too high, there is a risk of the system not recording when a key event occurs and losing that data.

From the experience of other crack and structural monitoring projects, the level selected for use in the field is 0.04 in/s for the ground motion geophone and 0.05 in/s for the internal structural geophones. For the air blast sensor, a typical trigger threshold is around 120 dB

Setting Kelunji EchoPro Trigger Levels

The Kelunji EchoPro can be programmed to record once a given trigger threshold is reached. However, this is complicated by the fact that the unit expresses the sensor outputs in terms of analog-digital steps as opposed to voltage or engineering units. The following section will discuss how to set the correct trigger threshold on the Kelunji EchoPro. For additional information on processes and EchoPro operation, please refer to Appendix A and the Kelunji EchoPro user manual

First, the interior geophones were set to trigger the Kelunji when their zero to peak output exceeded .05 in/s. According to the calculation below, a HS1 geophone with seventy percent damping

will trigger the Kelunji at 29360 A/D steps or .35 percent of the range. This is based on the assumption of using the full 10 Volt positive and negative range and the unit having 2²⁴ A/D steps (2²³ A/D steps from 0 to 10 V)

Kelunji EchoPro with Geospace HS1 geophone (70% damped)

X → A/D units		Y → in/s	
Equation: $Y = X * 10 / (2^{23} \text{ (V/A/D step)}) / 0.7 \text{ (V/in/s)}$			
Equation: $X = Y * 0.7 \text{ (V/in/s)} * 2^{23} / 10 \text{ (A/D steps/V)}$			
with Y =	0.05	in/s	
Trigger Level	29360.128	A/D steps	
Trigger Percent	0.35%	percentage	

The image below shows the process options. For the internal triggers, it uses channels 7-11 (structural geophones), and records a total of 10 seconds with a 1 second pre-trigger buffer.

Enabled

Process Name:

Process Type: Level Triggered

Trigger Channels												
1	2	3	4	5	6	7	8	9	10	11	12	Ext
<input type="checkbox"/>	<input type="checkbox"/>	<input type="checkbox"/>	<input type="checkbox"/>	<input type="checkbox"/>	<input type="checkbox"/>	<input checked="" type="checkbox"/>	<input checked="" type="checkbox"/>	<input checked="" type="checkbox"/>	<input checked="" type="checkbox"/>	<input checked="" type="checkbox"/>	<input type="checkbox"/>	<input type="checkbox"/>
N/A	N/A	N/A	N/A	N/A	N/A	N/A	N/A	N/A	N/A	N/A	N/A	N/A

Threshold: % of full scale

Pre-trigger Buffer: seconds

Total Record Length: seconds

Send SOH message every hours

Generate alarm on output

Select channels to record

1	2	3	4	5	6	7	8	9	10	11	12
<input checked="" type="checkbox"/>	<input checked="" type="checkbox"/>	<input checked="" type="checkbox"/>	<input checked="" type="checkbox"/>	<input checked="" type="checkbox"/>	<input checked="" type="checkbox"/>	<input checked="" type="checkbox"/>	<input checked="" type="checkbox"/>	<input checked="" type="checkbox"/>	<input checked="" type="checkbox"/>	<input checked="" type="checkbox"/>	<input checked="" type="checkbox"/>

Save locally Compress files

Send to :

Figure A 21: Kelunji Level Process

The exterior (buried) geophone and air overpressure gauge do not directly connect to the Kelunji EchoPro. However, they can still trigger the unit via the connection between the LARCOR compliance seismograph and the Kelunji. The output from the LARCOR to the EchoPro is a 5V step pulse. In order to trigger the EchoPro, another recording process was set up for channel 12 with a threshold of 45% (4.5 Volts).

Appendix H - Field Computation

Objective

The netbook, flash drive, and external hard drive serve as the main tool in the analysis and storage of data obtained from the deployment of the EchoPro recording system. The final output from the scripts and templates will require use of this hardware. This appendix will outline the use of these pieces of equipment.

Flash Drive

The flash (thumb) drive serves as the storage device for the Kelunji EchoPro while deployed in the field. The drive tested and verified to function as intended is the SanDisk Ultra Backup - USB flash drive - 64 GB. However, any flash drive that has a FAT32 file system should be compatible with the EchoPro recorder

The priority in selecting a flash drive is the storage capacity. The 64 GB device, with continuous recording of LVDTs and dynamic monitoring of all sensors, has adequate memory for one month of recording before a change is necessary. If recording takes place beyond this limit, old data will begin to be overwritten with new data.

The organization of the flash drive is shown in the figure below. The EchoPro files are stored in a folder labeled "Local Archive." Within this directory are three folders for each main process of the EchoPro. Cont0 contains the continuous process files. Level2 contains the interior triggered files. Level3 contains the exterior triggered files. Within these folders, the data is organized by year, month, day, and hour.



Name	Date modified	Type	Size	Tags	Name	Date modified	Type	Size	Tags
Local Archive	5/31/2011 10:05 AM	File Folder			cont0	5/31/2011 10:05 AM	File Folder		
Logs	5/31/2011 10:05 AM	File Folder			level2	5/31/2011 10:05 AM	File Folder		
					level3	5/31/2011 10:05 AM	File Folder		

Figure A 22: File System within Flash Drive

External Hard Drive

The external hard drive serves one primary purpose, storing data from multiple periods of deployment. Each month the unit is recording in the field, it requires an estimated 64 GB of storage space. If the unit were to be deployed for six months or a year, this number climbs to 6x64 GB and 12x64 GB.

Netbook

The netbook serves as the main computational device for the scripts and templates and a temporary data storage device for the data from the field. In order to use these tools, certain programs need to be installed. The automatic processing of the data by the scripts and templates in the netbook provide the basis for a technical report.

Necessary programs for the data collection and analysis include: Microsoft Excel, AutoHotkey, LOGiTpc Interface, and White seismograph analysis. Excel is necessary to run the templates that produce the summary tables and plots from the filtered deployment data. AutoHotkey runs the script that selectively filters the EchoPro deployment data. LOGiTpc allows data to be extracted from the SUPCO temperature and humidity loggers. White seismograph downloads and organizes data from the LARCOR compliance seismograph. These programs are located on the desktop of the netbook.

Similar to the programs outlined above, the EchoPro scripts and templates are located in a folder on the desktop labeled Kelunji software. The proper procedure for data retrieval and analysis is outlined in the EchoPro Analysis section of the user manual. Also, use of the specific software and templates are covered in the corresponding appendices.

Appendix I - Excel Analysis Templates

Objective

Microsoft Excel analysis templates simplify the analysis of data collected from the Kelunji EchoPro recorder and graph the selected results. They provide options for adjusting the data and graphs while automating much of the difficult processes involved with producing these results.

Long Term Analysis Template

The Long Term Analysis Template requires data from both the LVDT or other micrometer crack gauges being monitored continuously and the interior and exterior SUPCO temperature and humidity gauges. The document graphs this data and summarizes it within a table.

-Organization

These functions and outputs are organized within the six spreadsheet tabs within the document as follows:

- 1st tab is for Data Input
- 2nd tab is graphs of the 6 LVDT channels
- 3rd tab is graphs of selected LVDT and the 4 temperature and humidity channels.
- 4th tab is graphs of selected LVDT and 2 temperature and humidity channels.
- 5th tab provides graph options
- 6th tab displays a summary table of the calculated results for all channels.

The first tab within the document is shown in the two figures below. The primary purpose is to provide a space for data from the EchoPro recorder and SUPCO gauges to be entered and then converted to the correct engineering format for plotting. The key areas are numbered as follows.

1. The conversion factor for the LVDTs, in Volts/inch. Changing this number will automatically change the calculations within the document.

2. Kelunji EchoPro Hourly Data must be copied and pasted (numbers only) into this space. The columns include the date on the left and one for each possible LVDT channel on the recorder.
3. Internal temperature and humidity data from the SUPCO loggers must be copied and pasted (numbers only) into this space. Columns include the temperature, humidity, dew point, date/time, and most importantly, an **indicator** of what temperature and humidity value corresponds to the first entry of crack data. This indicator is crucial for aligning the graphs (discussed further within the user's manual)
4. This area is identical to 3, except it pertains to external temperature and humidity data.
5. This number points out the location of the Macros button within the view tab of the top ribbon of Excel. The scripts for properly using this document will be accessed via the Macros button.
6. The bottom-left side of the document shows all the tabs within the template. Use this area to change to different tabs of the document.
7. This space converts all the data from the EchoPro analog-digital units to engineering units.
8. This space centers all the data on the average to plot all data in relation to zero instead of some arbitrary scale.

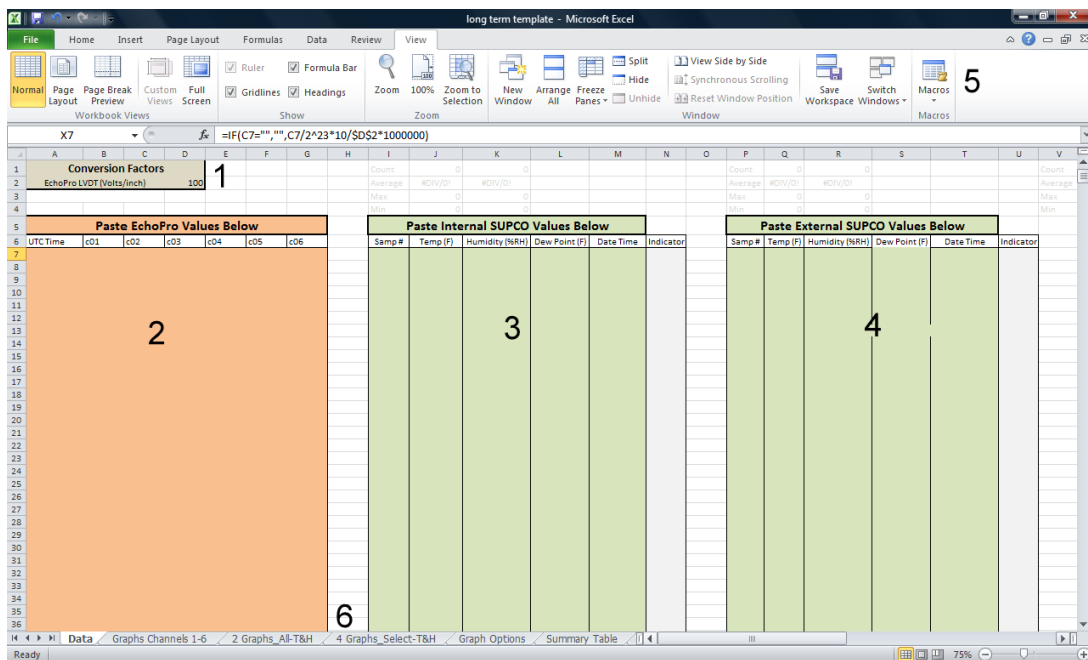

Figure A 23: Data Input Tab of the Long Term Analysis Template – Left Side

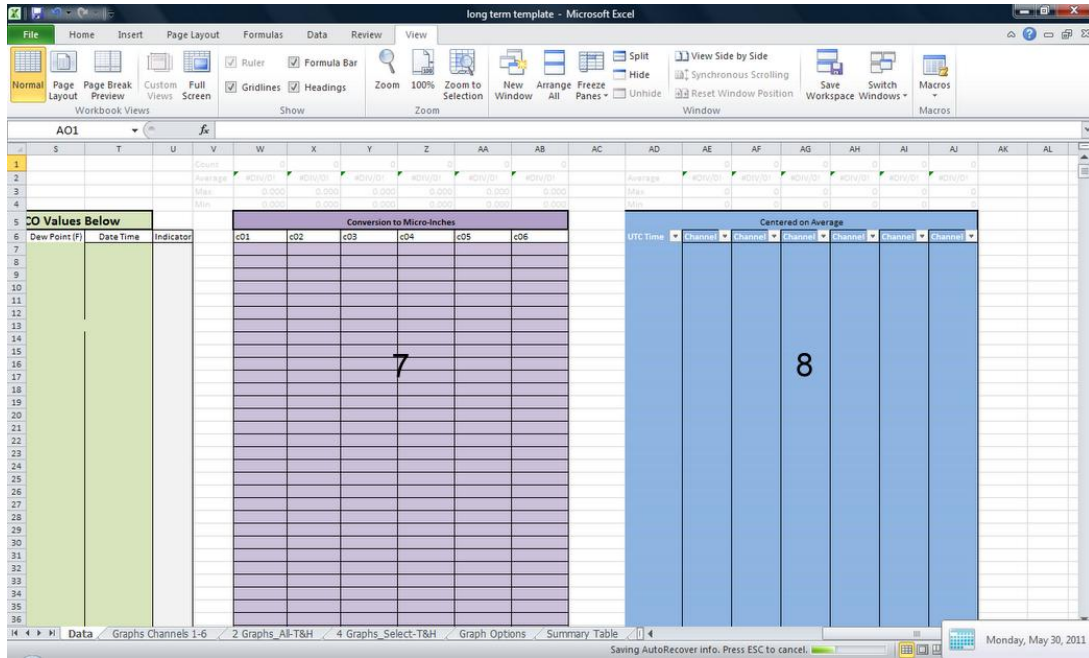

Figure A 24: Data Input Tab of the Long Term Analysis Template – Right Side

-Data Processing

Once the data from both the EchoPro and the SUPCO loggers are added into the template, they are automatically converted to engineering units and then centered on the average value of its time history. These processes are explained below.

Data conversion to engineering units uses the following formula:

$$Output \text{ (micro – inches)} = \frac{Input \text{ (AD steps)}}{2^{23} \text{ (Total AD steps)}} * \frac{10 \text{ Volts (nominal range)}}{100 \left(\frac{\text{Volts}}{\text{inch}} \right)} * 1,000,000 \left(\frac{\mu - in}{in} \right)$$

This formula takes an input of AD steps from the Kelunji, divides it by the Total AD range of the recorder, multiplies by the total nominal voltage range divided by the conversion factor and then multiplies this by the number of micro-inches per inch to calculate the output.

Centering the data on its average is carried out by the following formula that subtracts the average output of all the data points from each data point, which translates the graph to improve the plots.

$$Output \text{ (centered)} = Output \text{ (micro – inches)} - Average \text{ Output (micro – inches)}$$

-Plotting Results

Once these processes are completed, data within the template are ready to be plotted. This conversion occurs automatically within the document. Dynamic named ranges are used to select the correct data to plot. These dynamic ranges are in a format similar to the one for UTC time below.

$$UTCTime = OFFSET(Data! \$A\$7,0,0, COUNTA(Data! \$A: \$A) - 4)$$

This formula counts the number of cells with values in column A within the Data tab and selects the range of values to be plotted. These dynamic ranges are used directly as inputs into the graphs. This counting allows for different amounts of data and ranges to be graphed automatically by the template.

In order for the graphs to display the data correctly, three excel macro's were developed. These can be accessed with the macros button shown in the figure above (labeled number 5). The macros, named "y_axis", "x_axis", and "GraphTitles", are controlled by parameters within the graph options tab. The figure below highlights the two main areas in this tab.

- A. The y-axis and x-axis limits of all the graphs are determined automatically by a roundup calculation based on the Data from tab 1. However, these can also be set manually at the user's discretion.
- B. The Graph Titles gives the user the option to automatically label graphs as desired. While initial titles are given in this region, it is recommended that new titles are given with more specific information about the sensor (orientation, location, etc.).

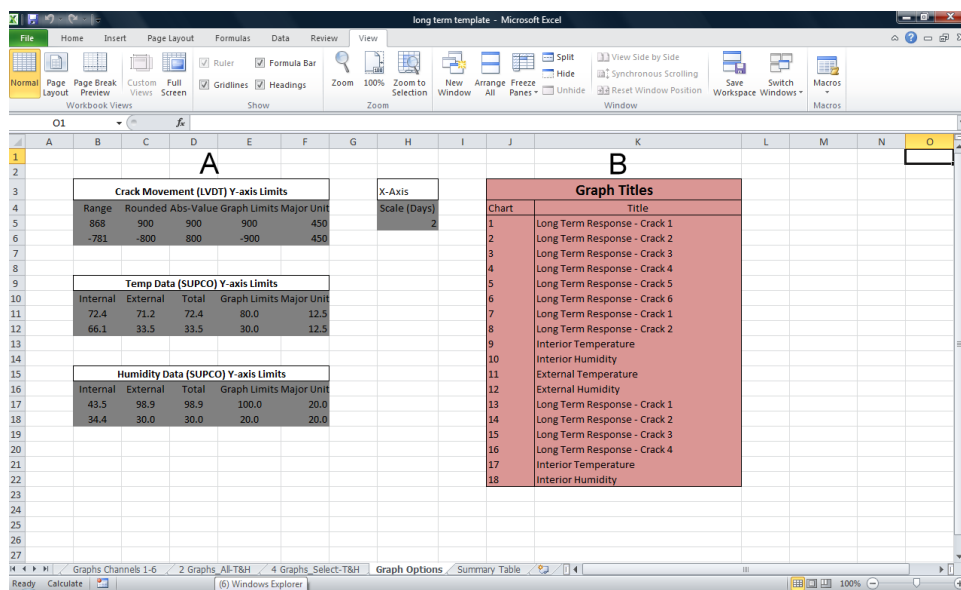

Figure A 25: Graph Options Tab of the Long Term Analysis Template

When running the macros, the current numbers or titles within areas A and B are used to modify the graphs to either default or user specified values. If changes are made to the graph options, the macros MUST be run again to transfer these modifications to the plots.

Dynamic Excitation Analysis Template

The Dynamic Excitation Analysis Template requires data from both the Kelunji EchoPro recorder and the LARCOR compliance seismograph. The document graphs this data and summarizes it within a table.

-Organization

These functions and outputs are organized within the eight spreadsheet tabs within the document as follows:

- 1st tab is for Data Input
- 2nd tab is graphs of the 6 LVDT channels
- 3rd tab has 3 selected LVDT and geophone channels.
- 4th tab has the 4 exterior channels from the LARCOR and one select LVDT and geophone channel.
- 5th tab has 2 displacement and 2 geophone channels.
- 6th tab displays 2 displacement and 2 LVDT channels and one relative displacement plot.
- 7th tab provides graph options
- 8th tab displays a summary table of the calculated results for all channels.

The first tab within the document is shown in the two figures below. The primary purpose is to provide a space for data from the EchoPro recorder and LARCOR seismograph to be entered and then converted to the correct engineering format for plotting. The key areas are numbered as follows.

1. The conversion factors for the LVDTs, in Volts/inch, and the geophones, in Volts/inch/second. Changing this number will automatically change the calculations within the document.
2. Kelunji EchoPro Hourly Data must be copied and pasted (numbers only) into this space. The columns include the time on the left and another column for each of the 12 channels.
3. LARCOR data must be copied and pasted (numbers only) into this space. Columns include the three tri-axial geophone outputs, the air blast, the time, and most importantly, an

indicator of when the trigger event occurred in the data. This indicator is crucial for aligning the graphs (discussed further within the user’s manual)

4. This space converts all the data from the EchoPro analog-digital units to engineering units.
5. This number points out the location of the Macros button within the view tab of the top ribbon of Excel. The scripts for properly using this document will be accessed via the Macros button.
6. The bottom-left side of the document shows all the tabs within the template. Use this area to change to different tabs of the document.
7. This space centers all the data on the average to plot all data in relation to zero instead of some arbitrary scale.
8. This space calculates the absolute structural displacement with data from the geophones.
9. This space calculates the relative displacement between two selected structural displacements.

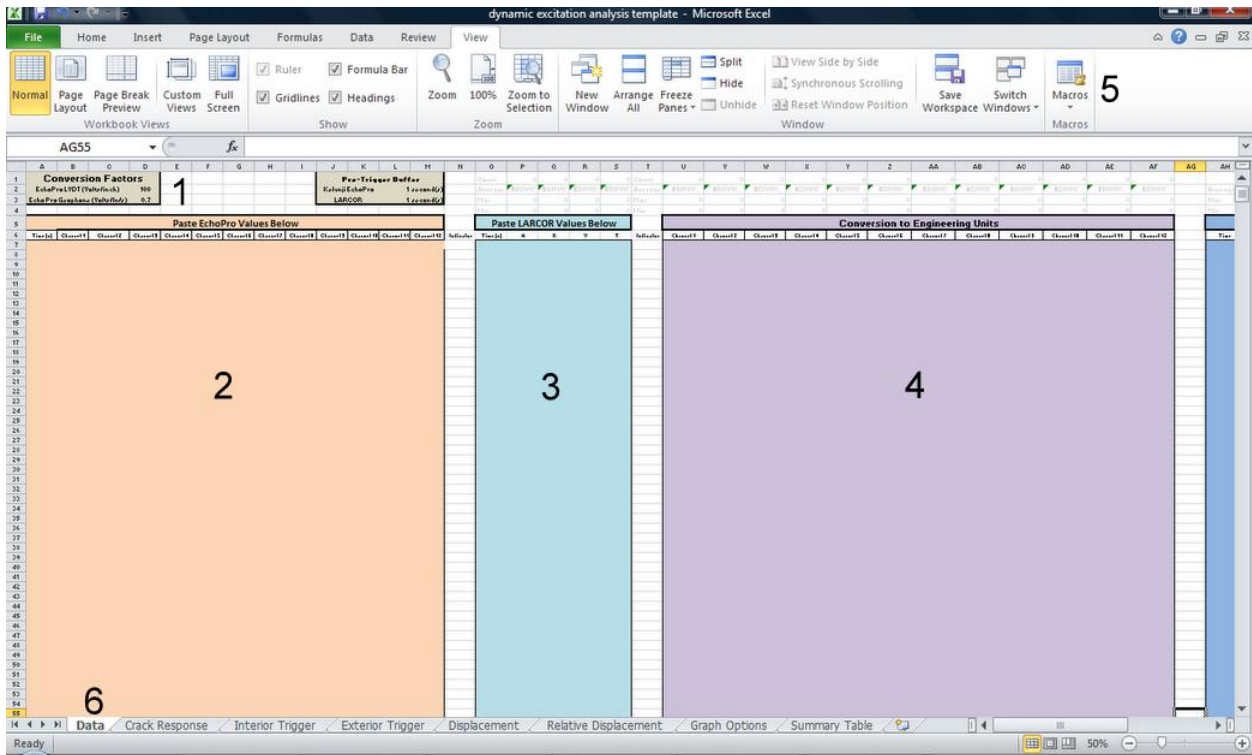

Figure A 26: Data Input Tab of Dynamic Analysis Template – Left Side

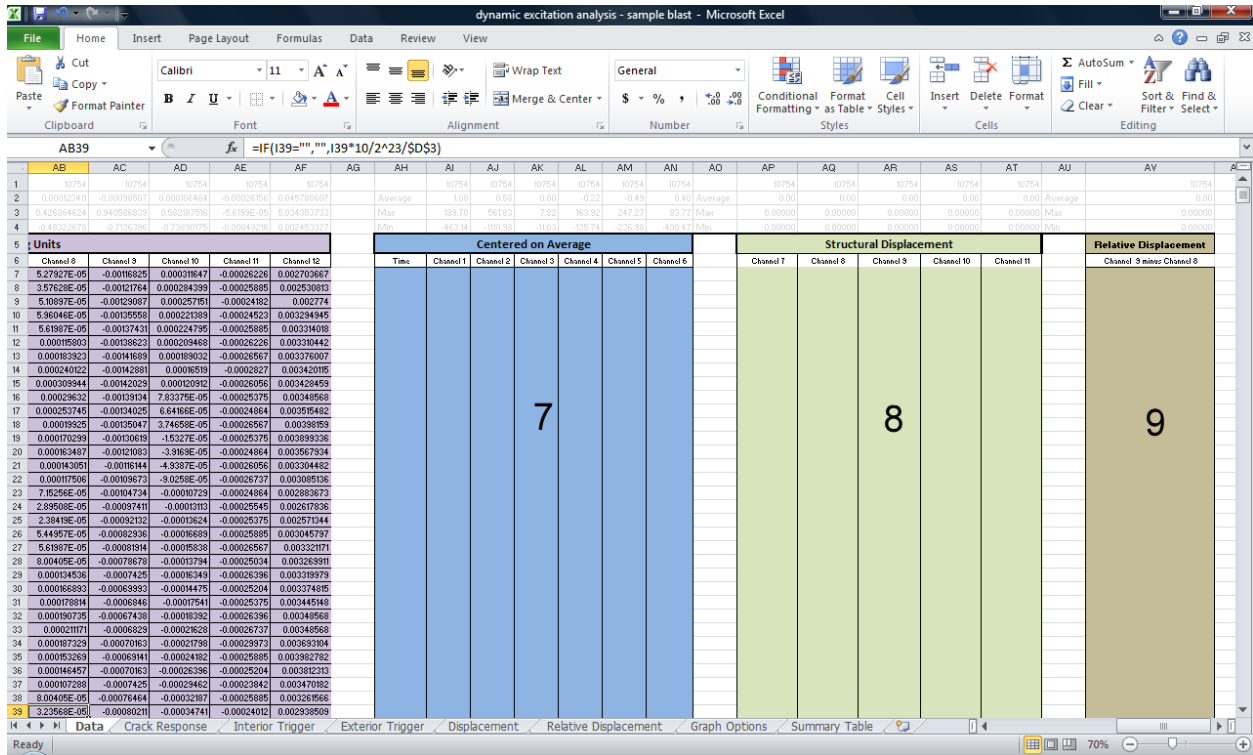

Figure A 27: Data Input Tab of the Dynamic Analysis Template – Right Side

-Data Processing

Once the data from both the EchoPro and the LARCOR units are added into the template, they are automatically converted (if necessary) to engineering units and then centered on the average value of its time history. These processes are explained below.

Data conversion to engineering units for the LVDTs uses the same formula as for the Long-Term Template and the formula can be found in the above section. The geophone conversion uses the following formula:

$$\text{Output (inches/second)} = \frac{\text{Input (AD steps)}}{2^{23}(\text{Total AD steps})} * \frac{10 \text{ Volts (nominal range)}}{.7 \left(\frac{\text{Volts}}{\text{inch/second}} \right)}$$

This formula takes an input of AD steps from the Kelunji, divides it by the Total AD range of the recorder, multiplies by the total nominal voltage range and divides it by the conversion factor provided to the template. Centering the LVDT data on its average uses the same equation as in the above section.

The structural displacements are calculated with the following equation:

Displacement (milli – inch)

$$= (\text{Geophone Output}(\text{Time } x + 1) - \text{Geophone Output}(\text{Time } x)) * \text{TimeStep} * 1000 \text{ (milli – in/in)}$$

This formula subtracts the next geophone output from the current one, multiplies by the time step, and converts to milli-inches, which is a simple way of integrating the data from inches per second to inches.

The relative displacements are calculated with the following equation:

$$\text{Relative displacement (milli – inch)} = \text{displacement (Channel X)} - \text{displacement (Channel Y)}$$

When two geophones are situated on opposite ends of a wall (top and bottom, far sides, etc.), the relative displacement of the ends can allow for a calculation of the strain in the wall.

-Plotting Results

Once these processes are completed, data within the template are ready to be plotted. This conversion occurs automatically within the document. Dynamic named ranges are used to select the correct data to plot. These dynamic ranges are in a format similar to the one for UTC time below.

$$\text{UTCtime}=\text{OFFSET}(\text{Data!}\$A\$7,0,0,\text{COUNTA}(\text{Data!}\$A:\$A)-4)$$

This formula counts the number of cells with values in column A within the Data tab and selects the range of values to be plotted. These dynamic ranges are used directly as inputs into the graphs. This counting allows for different amounts of data in different ranges to be graphed automatically by the template.

In order for the graphs to display the data correctly, three excel macro's were developed. These can be accessed with the macros button shown in the figure above (labeled number 5). The macros, named "y_axis" , "x_axis" and "GraphTitles", are controlled by parameters within the graph options tab. The figure below highlights the two main areas in this tab.

- A. The y-axis limits of all the graphs are determined automatically by a roundup calculation based on the Data from tab 1. However, these can also be set manually at the user's discretion.
- B. The x-axis limits of all the graphs are determined automatically by a roundup calculation based on the Data from tab 1. These can also be set manually by the user.
- C. The Graph Titles gives the user the option to automatically label graphs as desired. While initial titles are given in this region, it is recommended that new titles are given with more specific information about the sensor (orientation, location, etc.).

Crack Movement (LVDT) Y-Axis Limits					X-Axis Limits		Graph Titles	
Range	Rounded	Abs-Value	Graph Limits	Major Unit	Graph	Major Unit	Chart	Title
561.83	600.00	600.00	1200.00	600.00	11.000	1	1	Crack Response - Channel 1
-1110.98	-1200.00	1200.00	-1200.00	600.00	0.000	1	2	Crack Response - Channel 2
							3	Crack Response - Channel 3
							4	Crack Response - Channel 4
							5	Crack Response - Channel 5
							6	Crack Response - Channel 6
							7	Crack Response - Channel 1
							8	Crack Response - Channel 2
							9	Crack Response - Channel 3
							10	Structural Response - Channel 7
							11	Structural Response - Channel 8
							12	Structural Response - Channel 9
							13	Air Blast
							14	Radial Ground Motion
							15	Vertical Ground Motion
							16	Transverse Ground Motion
							17	Crack Response - Channel 2
							18	Structural Response - Channel 7
							19	Structural Response - Channel 8
							20	Structural Response - Channel 9
							21	Displacement - Channel 8
							22	Displacement - Channel 9
							23	Crack Response - Channel 4
							24	Crack Response - Channel 5
							25	Relative Displacement (8&9)
							26	Displacement - Channel 8
							27	Displacement - Channel 9

Structural Movement (Geophone) Y-Axis Limits					Y-label
Range	Rounded	Abs-Value	Graph Limits	Major Unit	
1.640	2.000	2.000	2.000	1.000	300
-1.363	-2.000	2.000	-2.000	1.000	

External Ground Motion (LARCOR) Y-Axis Limits				
Range	Rounded	Abs-Value	Graph Limits	Major Unit
2.80	2.80	2.80	3.00	1.50
-2.72	-3.00	3.00	-3.00	1.50

Air Blast (LARCOR) Y-Axis Limits				
Range	Rounded	Abs-Value	Graph Limits	Major Unit
112.00	120.00	120.00	120.00	60.00
0.00	0.00	0.00	0.00	60.00

Absolute Displacement Y-Axis Limits				
Range	Rounded	Abs-Value	Graph Limits	Major Unit
0.17478	0.20000	0.20000	0.30000	0.15000
-0.21906	-0.30000	0.30000	-0.30000	0.15000

Relative Displacement Y-Axis Limits				
Range	Rounded	Abs-Value	Graph Limits	Major Unit
0.18628	0.20000	0.20000	0.30000	0.15000
-0.20305	-0.30000	0.30000	-0.30000	0.15000

Data	Crack Response	Interior Trigger	Exterior Trigger	Displacement	Relative Displacement	Graph Options	Summary Table
------	----------------	------------------	------------------	--------------	-----------------------	---------------	---------------

Figure A 28: Graph Options Tab of the Dynamic Analysis Template

When running the macros, the current numbers or titles within areas A and B are used to modify the graphs to either default or user specified values. If changes are made to the graph options, the macros MUST be run again to transfer these modifications to the plots.

-Scaling Example

1. Open the Graph Scaling Example File
2. Navigate to the External Trigger Tab. The ground motion plots are shown in Figure A 29

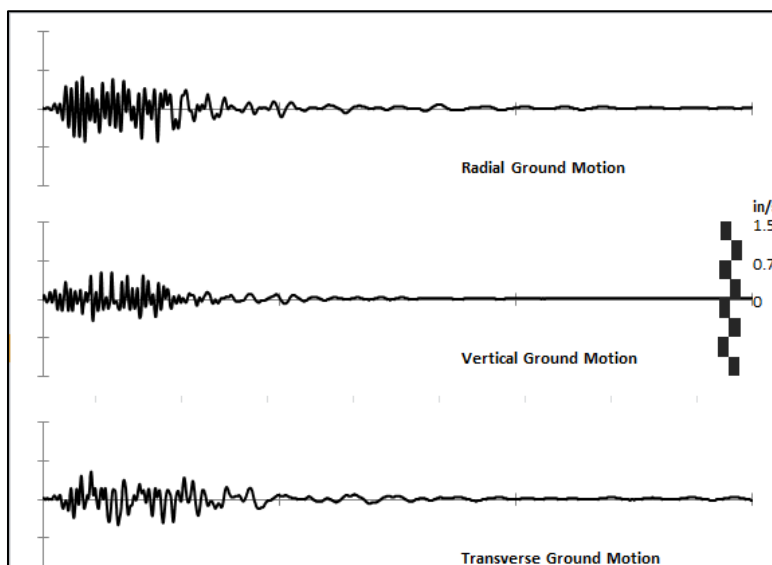

Figure A 29: Initial Scaling of Ground Motion Plots

3. Select the Graph Options Tab. Find the corresponding y-axis table (in this case: External Ground Motion (LARCOR) Y-Axis Limits).

4. Change the Graph Limits from -1.50 and 1.50 to -.75 and .75 as shown in Figure A 30.

Crack Movement (LVDT) Y-Axis Limits					X-Axis Limits	
Range	Rounded	Abs-Value	Graph Limits	Major Unit	Graph	Major Unit
45.10	45.10	45.10	300.00	150.00	4.000	1
-139.81	-200.00	200.00	-300.00	150.00	1.000	1

Structural Movement (Geophone) Y-Axis Limits					Y-label
Range	Rounded	Abs-Value	Graph Limits	Major Unit	
0.473	0.500	0.500	0.600	0.300	75
-0.569	-0.600	0.600	-0.600	0.300	

External Ground Motion (LARCOR) Y-Axis Limits				
Range	Rounded	Abs-Value	Graph Limits	Major Unit
0.62	1.00	1.00	0.75	0.38
-0.64	-0.70	0.70	-0.75	0.38

Air Blast (LARCOR) Y-Axis Limits				
Range	Rounded	Abs-Value	Graph Limits	Major Unit
0.02	0.02	0.02	0.02	0.01
0.02	0.00	0.00	0.00	0.01

Absolute Displacement Y-Axis Limits				
Range	Rounded	Abs-Value	Graph Limits	Major Unit
0.06401	0.07000	0.07000	0.05000	0.02500
-0.06108	-0.07000	0.07000	-0.05000	0.02500

Figure A 30: Altering Graph Limits for Scaling Example

5. Run the y-axis Macro.

6. View the results in the exterior trigger tab. They should look like the plots in Figure A 31.

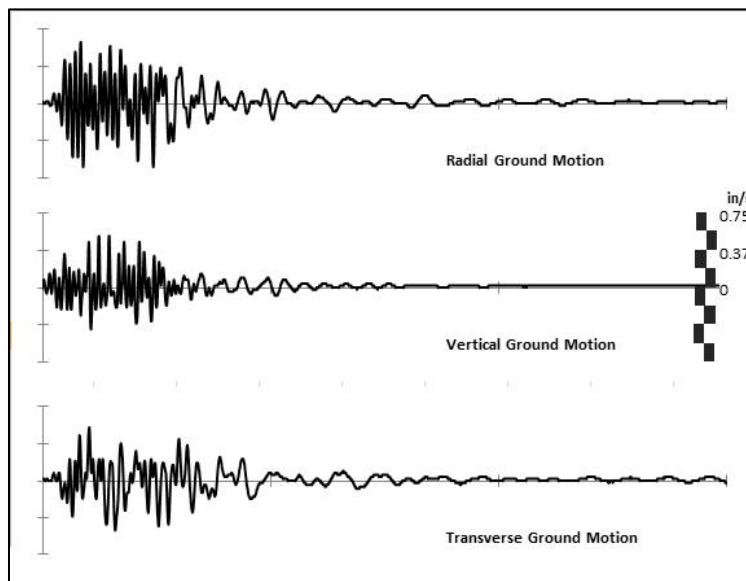

Figure A 31: Final Scaling of Ground Motion Plots

Appendix J - Filtering and Storage of Data

Objective

A script was developed to autonomously manage the large number of data files recorded by the Kelunji EchoPro. This script allows for the quick extraction and conversion of data from a removable flash hard drive, organized in text files. The program can be split into three main parts, as shown in the diagram below.

The Kelunji EchoPro samples all crack sensor outputs continuously at 1000 samples per second and stores the measurements in one minute long files. Thus, the archive for each transducer contains 60,000 points for each minute. Since, sub-sampling is not available with the EchoPro, the unwanted data must be filtered before analysis. Also, the EchoPro records any dynamic or burst events and stores them as single files in a separate directory.

Kelunji Script

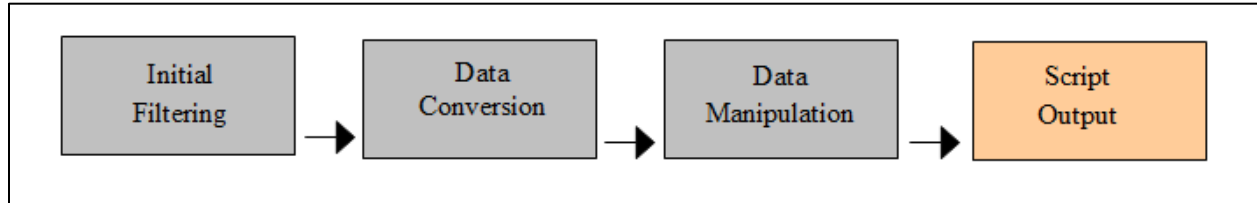

Figure 53: Processes of Kelunji EchoPro Script

-Initial Filtering

The first main subroutine selectively filters the EchoPro archive for the pertinent files from the recorder and copies them to the netbook. There are two file types of interest: long term response data and dynamic (burst) data.

The long term data requires extensive filtering due to the continuous recording of the sensors. The 60, one minute-long files with 60,000 data points in each minute are mostly unnecessary information. Therefore, the script archives the first one minute long files for every hour, which reduces the amount to be converted to 1/60 of the original data.

The dynamic events are archived in either the level 2 (internally triggered) or level 3 (externally triggered) directories. Each file is named with the time stamp associated with the trigger signal. The script copies the entire archive of dynamic files from the flash drive onto the local hard drive.

Once the necessary data is downloaded off the storage device, the script will move to the next main subroutine.

-Data Conversion

In order for the data files to be readily analyzed, they must have a file format that is easy to import into Microsoft Excel for analysis. Currently, the Kelunji uses a format called the Seismic Unified Data System (SUDS) (<http://www.banfill.net/suds.html>). The command-line utility that converts these files is part of a free-available software package called Win-SUDS. The script transforms conversion of the data files from .dmx to .txt format from a command line program to an autonomous process. This process is complicated by the initial layout of the new text files. Data for each channel is expressed in up to ten columns, which would make analysis nearly impossible. The program alters the text files to display each channel's output in one column with a universal time stamp in another column. The miscellaneous information for the recorder and the channels is preserved but separated from the output columns to prevent confusion. The files generated are designed to be easily viewable within Microsoft Excel or similar programs. With the data conversion completed, the script will continue by manipulating the data to facilitate future analysis.

-Data Manipulation

The subroutine to help manipulate the data is partially completed and requires future developments before it can be deemed a finished product. Currently, the software executed the following processes.

The long term data only requires one data point per hour for the output of the crack sensors. This data point is obtained by averaging the first 1000 points of the selected, one minute long records for each hour, as described above. These averages are compiled in column form within the hourly

averages text file. A sample of this output in excel is shown in Figure 54. Temperature and humidity long term data are automatically recorded each hour as a single point by the SUPCO gauge, as described in Appendix E. They can be compared graphically with the long term crack response with standard excel graphing.

	A	B	C	D	E	F	G
1	UTC Time	c01	c02	c03	c04	c05	c06
2	01/25/11 07:26 PM	8388607	2835584.99	-300733.65	3862408.73	-623065.06	-1370.1
3	01/25/11 08:26 PM	4910340.63	2899449.63	3579198.76	5724355.82	2046737.7	-1345.16
4	01/25/11 09:26 PM	4911984.55	2895799.76	3578934.35	5724800.33	2047610.11	-1340.39
5	01/25/11 10:26 PM	4913580.09	2895764.44	3578728.31	5726216.96	2047967.3	-1342.03
6	01/25/11 11:26 PM	4914694.99	2895676.23	3578315.03	5727784.81	2049059.76	-1340.84
7	01/26/11 12:26 AM	4916402.52	2896019.6	3578393.09	5728995.73	2048783.79	-1337.63
8	01/26/11 01:26 AM	4917089.11	2895976.3	3578485.7	5727900.29	2047652.28	-1338.16
9	01/26/11 02:26 AM	4917806.13	2896035.46	3578442.79	5728969.81	2048175.49	-1338
10	01/26/11 03:26 AM	4918487.55	2896122.95	3578049.3	5730321.19	2049144.58	-1338.77
11	01/26/11 04:26 AM	4919394.26	2896094.44	3578177.27	5730552.52	2049513.79	-1338.97
12	01/26/11 05:26 AM	4919940.32	2895951.82	3577899.71	5731682.15	2049970.33	-1337.5
13	01/26/11 06:26 AM	4920565.58	2896141.66	3578199.82	5732318.08	2049851.44	-1340.68
14	01/26/11 07:26 AM	4921237.34	2896101.82	3578011.69	5732804.57	2050437.37	-1339.14
15	01/26/11 08:26 AM	4921622.72	2896154.82	3578127.4	5733533.16	2050129.17	-1340.77
16	01/26/11 09:26 AM	4921990.11	2896115.88	3578023.41	5733734.95	2050421.15	-1338.18

Figure 54: Sample Hourly Averages Output in Excel

The triggered data does not require any manipulation as the entire time history for each channel will be needed for display and analysis.

The next step in software development is to provide a graphical user interface that will allow users to adjust the program and its output. With this completed, the script could ask for an input, such as a conversion factor, and express the final outputs in engineering units. At the moment, all of the script outputs are in terms of A/D steps which must be converted separately from the script after its completion. The GUI would also help improve the flexibility of the program by allowing users to dictate sensors for each channel, where output files should be saved, and numerous other possibilities.

-Script Output

The final output of these subroutines is contained in a folder, labeled by the timestamp of when the script was executed. The folder contains a separate text file for each triggered event and one file for the hourly averages obtained from the continuous crack data. The triggered records are named by the date and time of the triggering event. There is also a temp folder containing all of the original files from the initial filtering. The script output is shown in Figure 55 and Figure 56

Name	Date modified	Type	Size	Tags
temp				
2011-01-25_1329_59_ECHOP.dms.bt.columnized	2011-01-26_1320_20_ECHOP.dms.bt.columnized	2011-01-27_1624_01_ECHOP.dms.bt.columnized	2011-01-28_1830_28_ECHOP.dms.bt.columnized	
2011-01-25_1342_56_ECHOP.dms.bt.columnized	2011-01-26_1321_53_ECHOP.dms.bt.columnized	2011-01-27_1627_49_ECHOP.dms.bt.columnized	2011-01-29_1550_43_ECHOP.dms.bt.columnized	
2011-01-25_1413_02_ECHOP.dms.bt.columnized	2011-01-26_1329_54_ECHOP.dms.bt.columnized	2011-01-27_1637_50_ECHOP.dms.bt.columnized	2011-01-31_0756_02_ECHOP.dms.bt.columnized	
2011-01-25_1505_09_ECHOP.dms.bt.columnized	2011-01-26_1331_06_ECHOP.dms.bt.columnized	2011-01-27_1656_50_ECHOP.dms.bt.columnized	2011-01-31_0813_19_ECHOP.dms.bt.columnized	
2011-01-25_1519_48_ECHOP.dms.bt.columnized	2011-01-26_1337_15_ECHOP.dms.bt.columnized	2011-01-27_1711_39_ECHOP.dms.bt.columnized	2011-01-31_0902_25_ECHOP.dms.bt.columnized	
2011-01-25_1542_48_ECHOP.dms.bt.columnized	2011-01-26_1352_52_ECHOP.dms.bt.columnized	2011-01-27_1956_07_ECHOP.dms.bt.columnized	2011-01-31_0958_17_ECHOP.dms.bt.columnized	
2011-01-25_1544_01_ECHOP.dms.bt.columnized	2011-01-26_1356_42_ECHOP.dms.bt.columnized	2011-01-27_1956_47_ECHOP.dms.bt.columnized	2011-01-31_0958_17_ECHOP.dms.bt.columnized	
2011-01-25_1545_12_ECHOP.dms.bt.columnized	2011-01-26_1430_56_ECHOP.dms.bt.columnized	2011-01-28_0706_13_ECHOP.dms.bt.columnized	2011-01-31_1021_30_ECHOP.dms.bt.columnized	
2011-01-25_1605_19_ECHOP.dms.bt.columnized	2011-01-26_1500_30_ECHOP.dms.bt.columnized	2011-01-28_0707_38_ECHOP.dms.bt.columnized	2011-01-31_1032_16_ECHOP.dms.bt.columnized	
2011-01-25_1622_12_ECHOP.dms.bt.columnized	2011-01-26_1538_10_ECHOP.dms.bt.columnized	2011-01-28_0712_34_ECHOP.dms.bt.columnized	2011-01-31_1147_58_ECHOP.dms.bt.columnized	
2011-01-25_1626_15_ECHOP.dms.bt.columnized	2011-01-26_1543_54_ECHOP.dms.bt.columnized	2011-01-28_0911_18_ECHOP.dms.bt.columnized	2011-01-31_1224_00_ECHOP.dms.bt.columnized	
2011-01-25_1636_31_ECHOP.dms.bt.columnized	2011-01-26_1618_35_ECHOP.dms.bt.columnized	2011-01-28_0914_58_ECHOP.dms.bt.columnized	2011-01-31_1225_38_ECHOP.dms.bt.columnized	
2011-01-25_1656_31_ECHOP.dms.bt.columnized	2011-01-26_1727_40_ECHOP.dms.bt.columnized	2011-01-28_0917_08_ECHOP.dms.bt.columnized	2011-01-31_1234_16_ECHOP.dms.bt.columnized	
2011-01-25_1947_38_ECHOP.dms.bt.columnized	2011-01-26_1845_15_ECHOP.dms.bt.columnized	2011-01-28_0926_52_ECHOP.dms.bt.columnized	2011-01-31_1312_05_ECHOP.dms.bt.columnized	
2011-01-25_1952_55_ECHOP.dms.bt.columnized	2011-01-26_1845_57_ECHOP.dms.bt.columnized	2011-01-28_0935_52_ECHOP.dms.bt.columnized	2011-01-31_1316_16_ECHOP.dms.bt.columnized	
2011-01-26_0838_22_ECHOP.dms.bt.columnized	2011-01-26_1848_57_ECHOP.dms.bt.columnized	2011-01-28_0951_28_ECHOP.dms.bt.columnized	hourly_averages	
2011-01-26_0834_21_ECHOP.dms.bt.columnized	2011-01-26_2012_21_ECHOP.dms.bt.columnized	2011-01-28_0959_49_ECHOP.dms.bt.columnized		
2011-01-26_0911_41_ECHOP.dms.bt.columnized	2011-01-27_0823_58_ECHOP.dms.bt.columnized	2011-01-28_1109_07_ECHOP.dms.bt.columnized		
2011-01-26_0938_47_ECHOP.dms.bt.columnized	2011-01-27_0824_53_ECHOP.dms.bt.columnized	2011-01-28_1117_52_ECHOP.dms.bt.columnized		
2011-01-26_1041_49_ECHOP.dms.bt.columnized	2011-01-27_0902_23_ECHOP.dms.bt.columnized	2011-01-28_1149_15_ECHOP.dms.bt.columnized		
2011-01-26_1042_56_ECHOP.dms.bt.columnized	2011-01-27_1023_04_ECHOP.dms.bt.columnized	2011-01-28_1156_11_ECHOP.dms.bt.columnized		
2011-01-26_1129_23_ECHOP.dms.bt.columnized	2011-01-27_1026_14_ECHOP.dms.bt.columnized	2011-01-28_1201_14_ECHOP.dms.bt.columnized		
2011-01-26_1132_23_ECHOP.dms.bt.columnized	2011-01-27_1038_16_ECHOP.dms.bt.columnized	2011-01-28_1249_22_ECHOP.dms.bt.columnized		
2011-01-26_1137_59_ECHOP.dms.bt.columnized	2011-01-27_1125_01_ECHOP.dms.bt.columnized	2011-01-28_1329_29_ECHOP.dms.bt.columnized		
2011-01-26_1139_05_ECHOP.dms.bt.columnized	2011-01-27_1139_15_ECHOP.dms.bt.columnized	2011-01-28_1359_25_ECHOP.dms.bt.columnized		
2011-01-26_1153_50_ECHOP.dms.bt.columnized	2011-01-27_1136_08_ECHOP.dms.bt.columnized	2011-01-28_1533_01_ECHOP.dms.bt.columnized		
2011-01-26_1216_10_ECHOP.dms.bt.columnized	2011-01-27_1247_46_ECHOP.dms.bt.columnized	2011-01-28_1607_08_ECHOP.dms.bt.columnized		
2011-01-26_1250_21_ECHOP.dms.bt.columnized	2011-01-27_1315_18_ECHOP.dms.bt.columnized	2011-01-28_1628_43_ECHOP.dms.bt.columnized		
2011-01-26_1306_37_ECHOP.dms.bt.columnized	2011-01-27_1340_32_ECHOP.dms.bt.columnized	2011-01-28_1655_31_ECHOP.dms.bt.columnized		
2011-01-26_1307_35_ECHOP.dms.bt.columnized	2011-01-27_1350_59_ECHOP.dms.bt.columnized	2011-01-28_1656_54_ECHOP.dms.bt.columnized		
2011-01-26_1309_46_ECHOP.dms.bt.columnized	2011-01-27_1355_13_ECHOP.dms.bt.columnized	2011-01-28_1658_08_ECHOP.dms.bt.columnized		
2011-01-26_1314_12_ECHOP.dms.bt.columnized	2011-01-27_1357_01_ECHOP.dms.bt.columnized	2011-01-28_1819_13_ECHOP.dms.bt.columnized		
	2011-01-27_1447_23_ECHOP.dms.bt.columnized	2011-01-28_1825_53_ECHOP.dms.bt.columnized		

Figure 55: Sample Script Output

Name	Date modified	Type	Size
2011-01-25_1329_59_E...	2/7/2011 3:31 PM	Text Document	468 KB
2011-01-25_1342_56_E...	2/7/2011 3:31 PM	Text Document	465 KB
2011-01-25_1413_02_E...	2/7/2011 3:31 PM	Text Document	466 KB
Long Term Data			
Dynamic Events			
Abridged Archive			
2011-01-31_1234_16_E...	2/7/2011 3:34 PM	Text Document	462 KB
2011-01-31_1312_05_E...	2/7/2011 3:34 PM	Text Document	465 KB
2011-01-31_1316_16_E...	2/7/2011 3:34 PM	Text Document	464 KB
hourly_averages	2/7/2011 3:34 PM	Text Document	16 KB

Figure 56: Abridged Script Output

Appendix K – Sample Data Practice Example: Excel Templates

Objective

Proper processing of the data obtained from the EchoPro and other sensor systems is vital to obtaining correct tables and plots. Data from a deployment of the system at Sycamore, IL was used to create sample files and sample outputs that can serve as a training exercise in the use of the excel templates. This will give users experience to improve results when analyzing field data.

Procedure

To rehearse the use of the excel templates, first locate the sample data. As shown in Figure A 32, these files are located in a folder on the desktop named Kelunji software -> excel templates -> template example files. The excel templates are located in the excel templates folder.

The user should follow the instructions in the Excel Templates subsection of the EchoPro Analysis – Software, Scripts, and Templates section of the user manual. There are separate processes for both the long term template and the dynamic excitation template. The results of the templates should be identical to the tables and plots shown in the outputs section below.

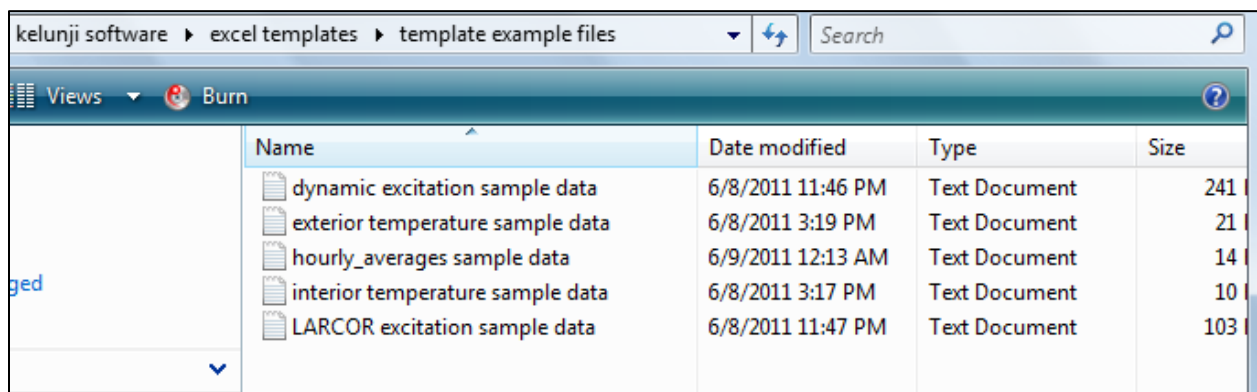

Figure A 32: Location of Sample Data Files

Outputs

The outputs generated from the two excel templates are shown in the figures below. The tables generated by the instructions may look slightly different based on the user entered descriptions and titles but the numbers for the channels should be the same. The output graphs, unless the scaling was manually altered, should be identical to the ones in this Appendix.

-Long Term Practice Outputs – Sample Data

Table A 1: Long Term Sample Data Table

Long Term Sample Data		Sample Long Term Data to Check the Process Outlined by the User Manual		
4/13/11 - 4/17/11				
Kelunji EchoPro				
Channel	Description	Maximum	Minimum	Unit
1	Response - Crack 1	360	-637	μ-in
2	Response - Crack 2	868	-781	μ-in
3	Response - Crack 3	24	-36	μ-in
4	Response - Crack 4	146	-266	μ-in
5	Response - Crack 5	200	-210	μ-in
6	Response - Crack 6	81	-115	μ-in
Interior SUPCO Temperature and Humidity Logger				
Channel	Description	Maximum	Minimum	Unit
Temp	Interior Temperature	72.430	66.080	°F
Hum	Interior Humidity	43.500	34.400	%
Exterior SUPCO Temperature and Humidity Logger				
Channel	Description	Maximum	Minimum	Unit
Temp	External Temperature	71.222	33.494	°F
Hum	External Humidity	98.886	29.989	%

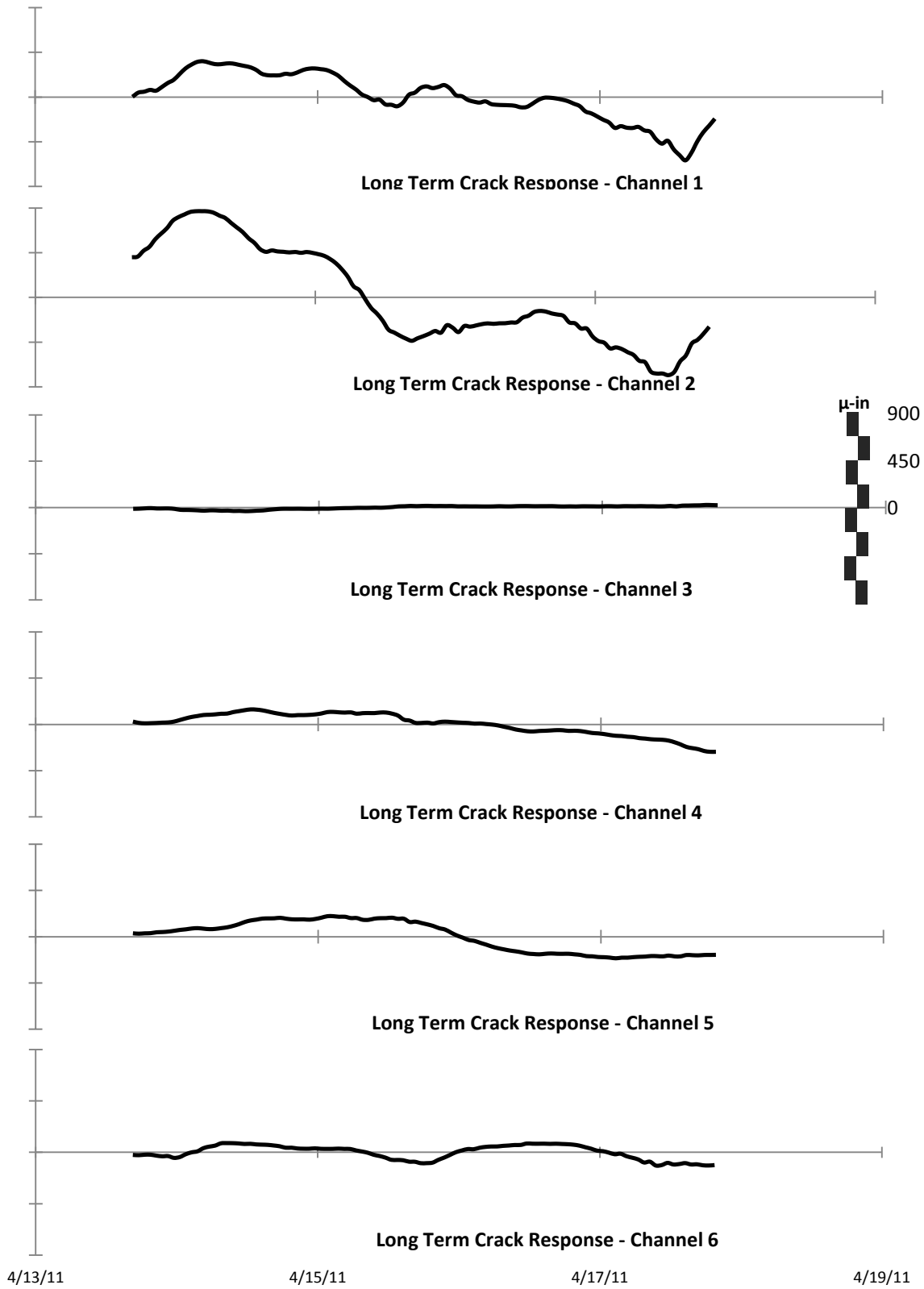

Figure A 33: Long Term Sample Plot - Tab 2

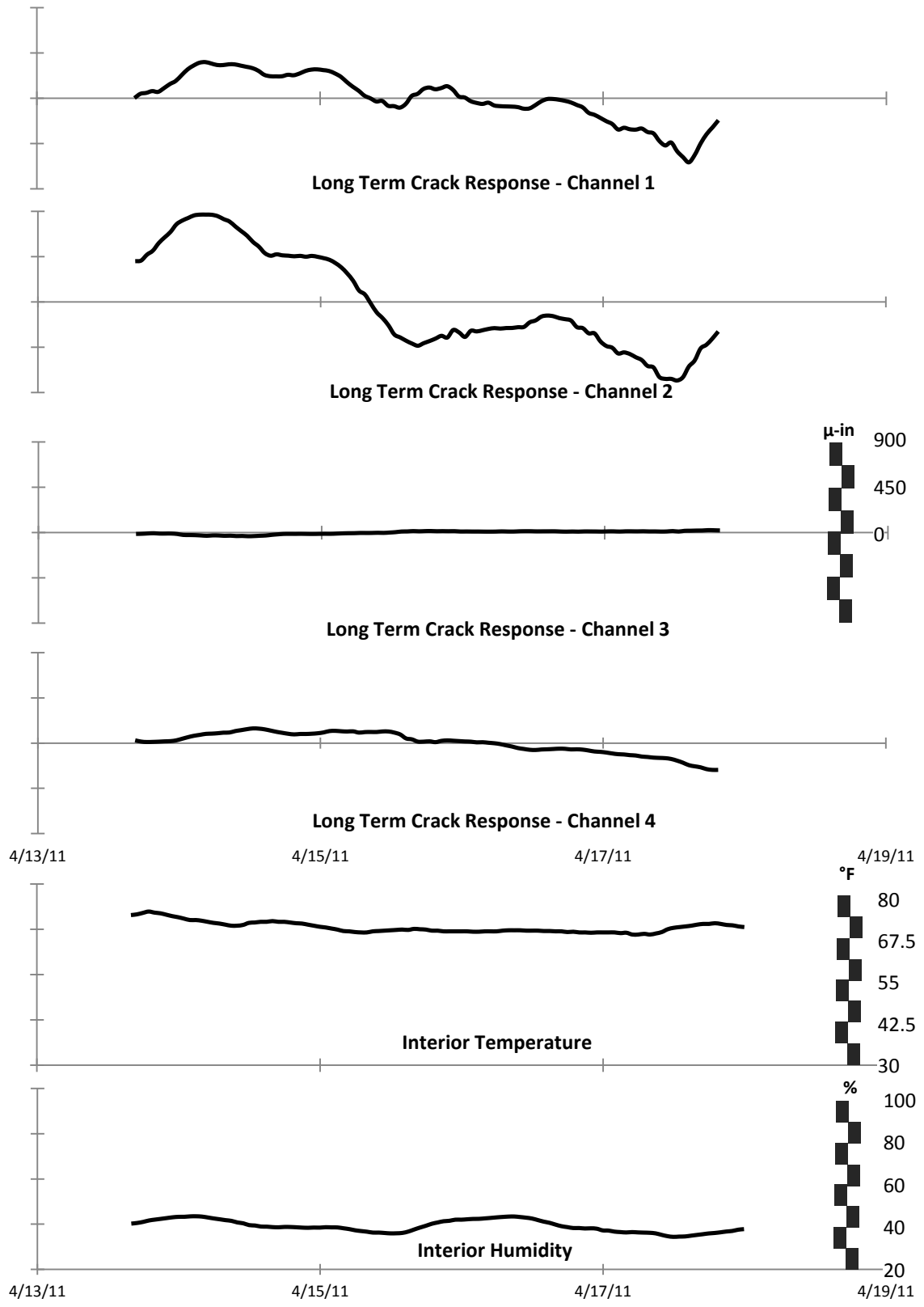

Figure A 34: Long Term Sample Plot - Tab 3

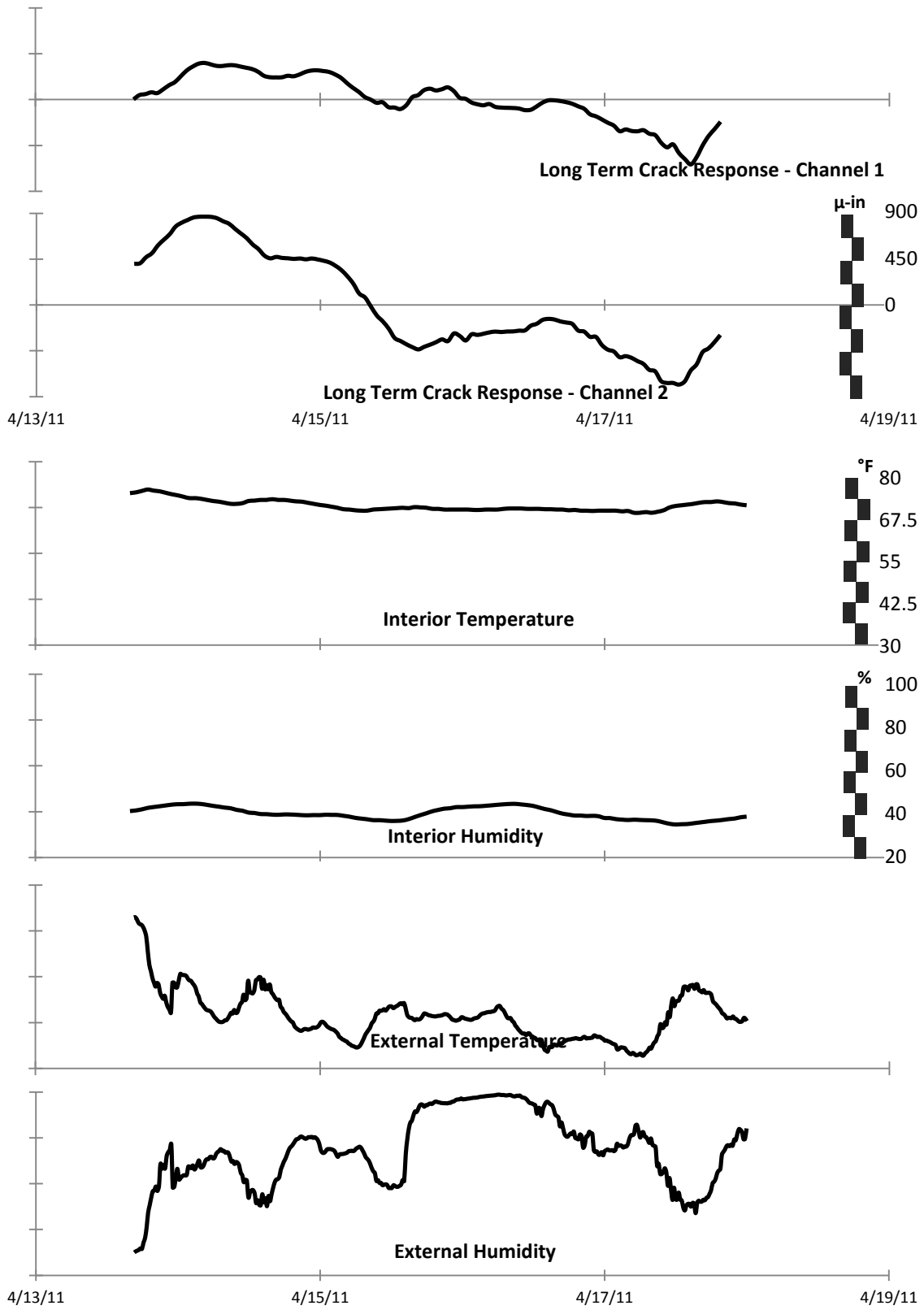

Figure A 35: Long Term Sample Plot - Tab 4

-Dynamic Excitation Practice Outputs – Sample Data

Table A 2: Dynamic Excitation Sample Table

Dynamic Excitation Sample Data		Sample Dynamic Excitation Data to Check the Process Outlined by the User Manual		
April 20th 2011 09:53				
Kelunji EchoPro				
Channel	Description	Maximum	Minimum	Unit
1	Crack Response - Channel 1	425	-228	μ-in
2	Crack Response - Channel 2	702	-971	μ-in
3	Crack Response - Channel 3	7	-11	μ-in
4	Crack Response - Channel 4	126	-174	μ-in
5	Crack Response - Channel 5	157	-327	μ-in
6	Crack Response - Channel 6	187	-274	μ-in
7	Structural Response - Channel 7	1.64	-1.36	in/s
8	Structural Response - Channel 8	0.43	-0.48	in/s
9	Structural Response - Channel 9	0.94	-0.71	in/s
10	Structural Response - Channel 10	0.58	-0.74	in/s
11	Structural Response - Channel 11	0.00	0.00	in/s
12	Trigger Signal - Channel 12	5.03	0.00	Volts
LARCOR Seismograph				
Channel	Description	Maximum	Minimum	Unit
A	Air Blast	112	0	Decibels
R	Radial Ground Motion	2.12	-1.82	in/s
V	Vertical Ground Motion	2.48	-1.86	in/s
T	Transverse Ground Motion	2.8	-2.72	in/s
Displacement				
Channel	Description	Maximum	Minimum	Unit
7	Absolute Displacement - Channel 7	0.175	-0.219	milli-in
8	Absolute Displacement - Channel 8	0.091	-0.072	milli-in
9	Absolute Displacement - Channel 9	0.140	-0.141	milli-in
10	Absolute Displacement - Channel 10	0.053	-0.057	milli-in
11	Absolute Displacement - Channel 11	0.000	0.000	milli-in
Ch9 - Ch8	Relative Displacement (Ch 9 - Ch8)	0.186	-0.203	milli-in

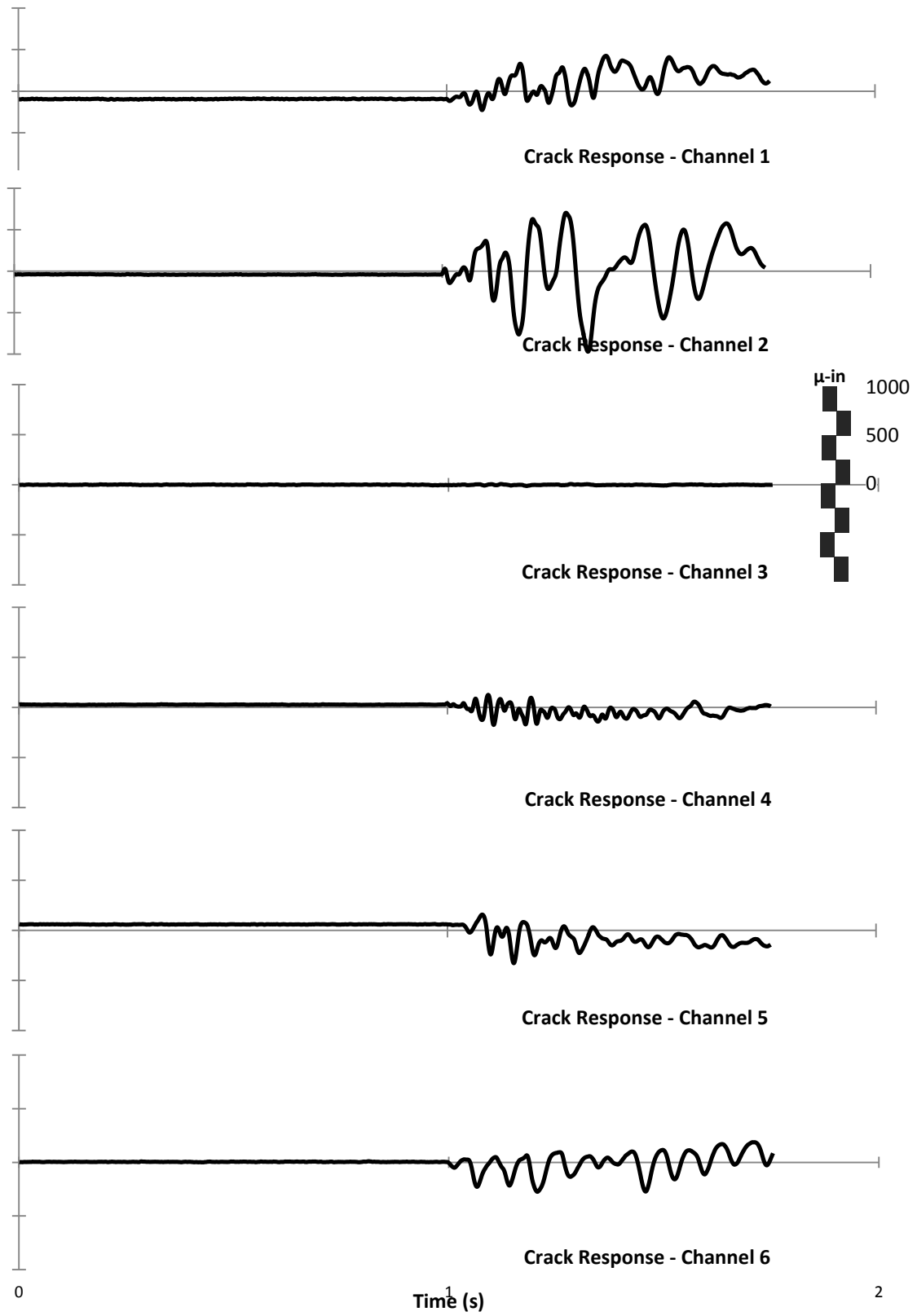

Figure A 36: Dynamic Excitation Sample Plot - Tab 2

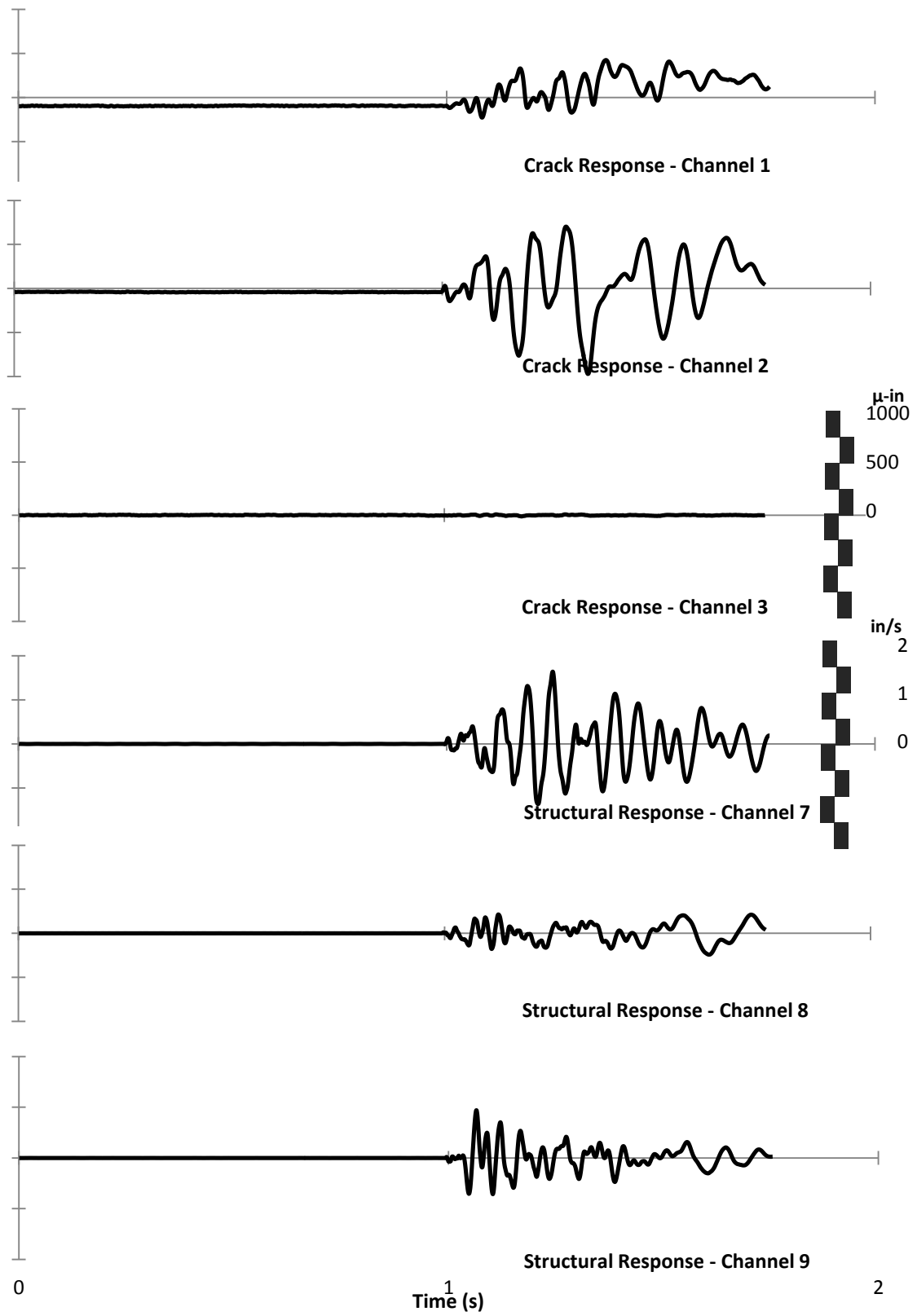

Figure A 37: Dynamic Excitation Sample Plot - Tab 3

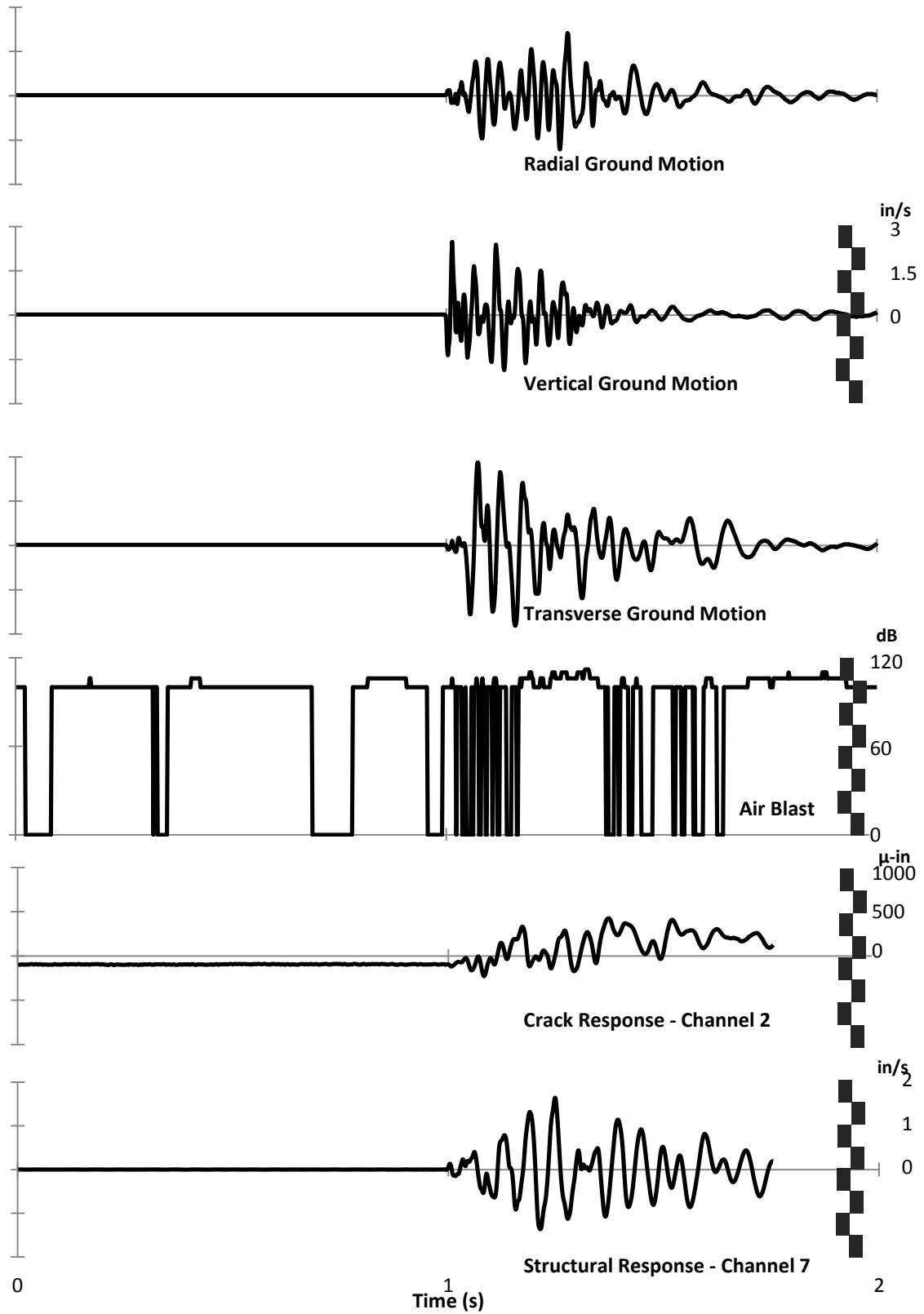

Figure A 38: Dynamic Excitation Sample Plot - Tab 4

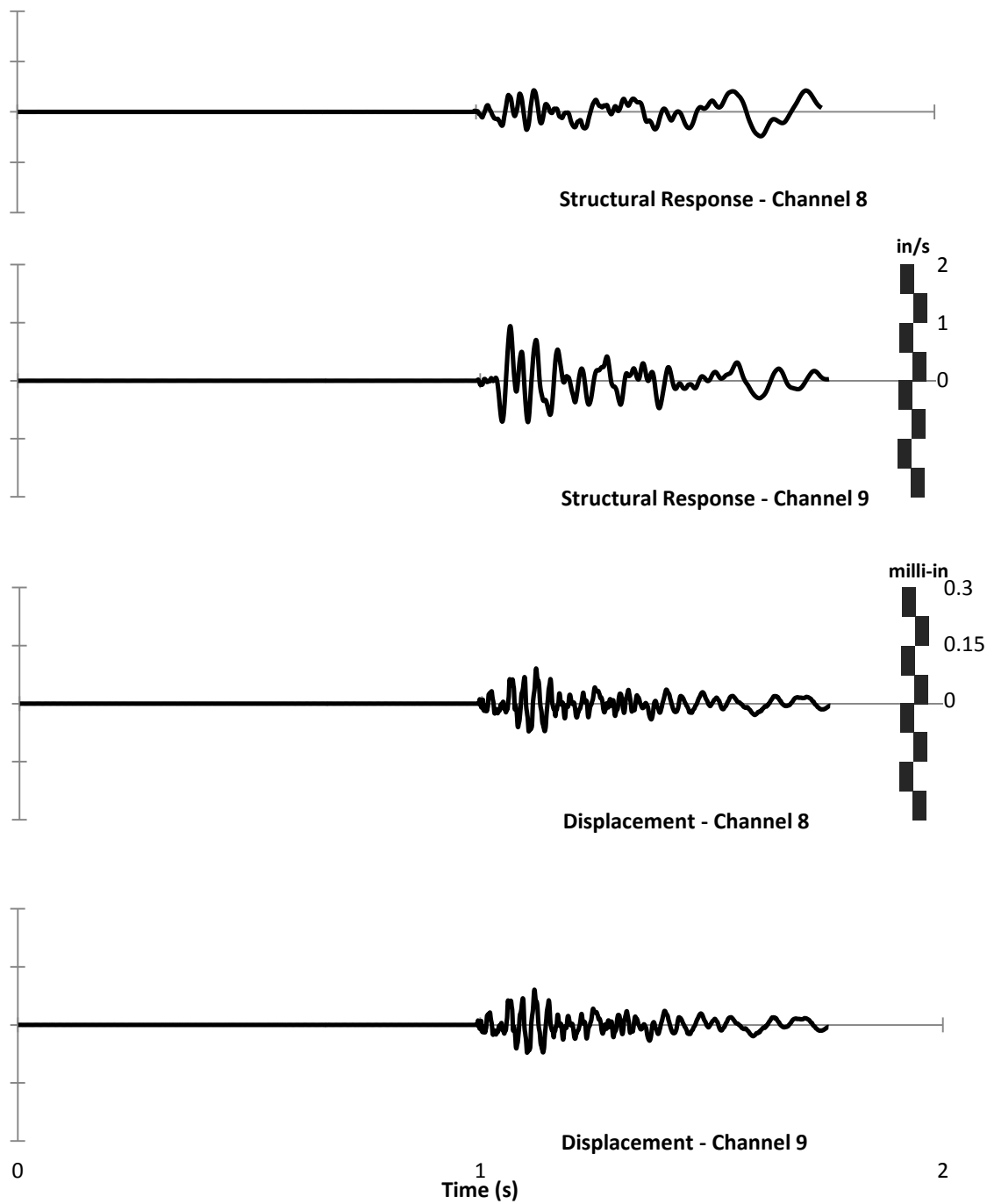

Figure A 39: Dynamic Excitation Sample Plot - Tab 5

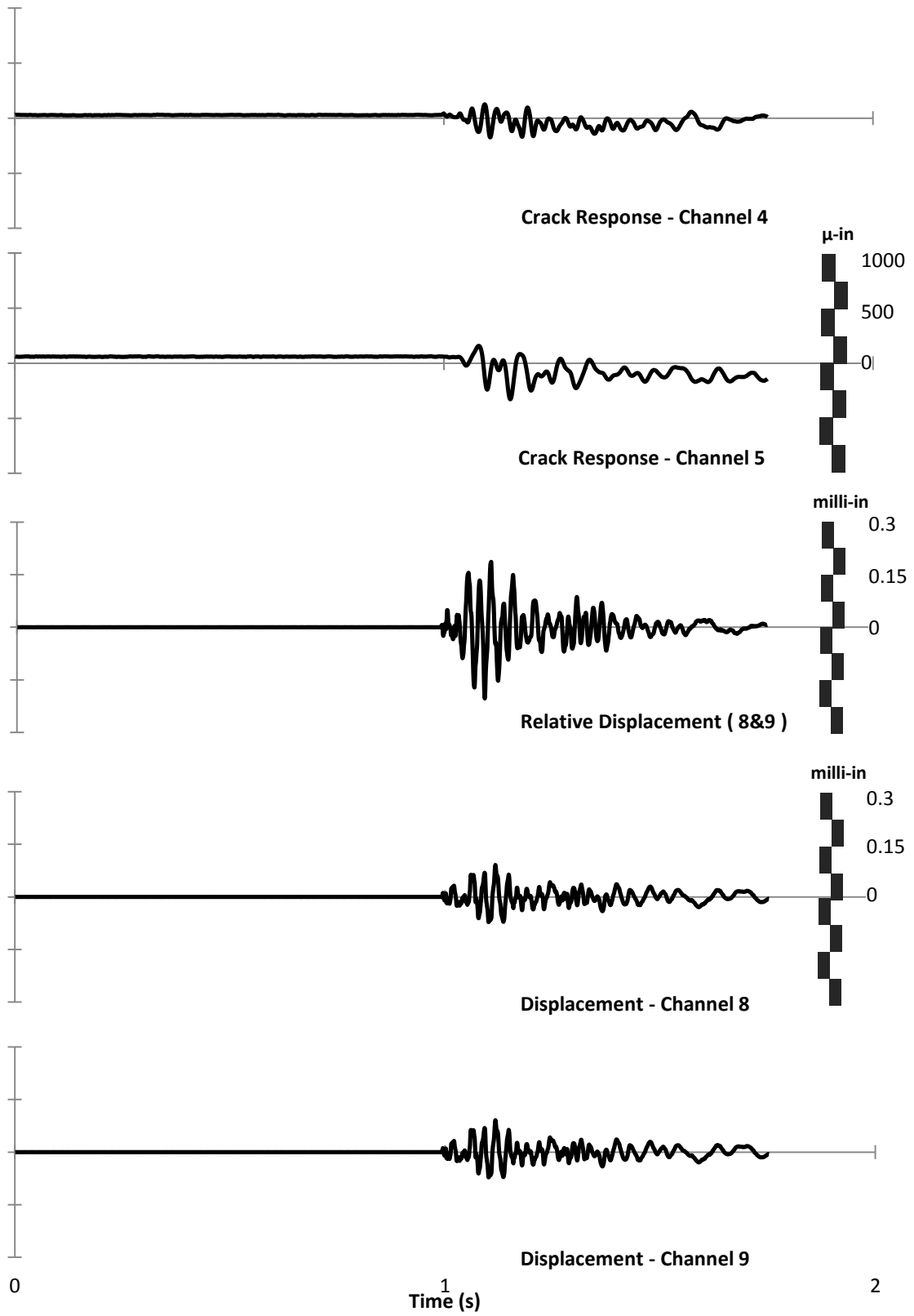

Figure A 40: Dynamic Excitation Sample Plot - Tab 6

Appendix L - Excel Template Modifications

The original excel templates displayed crack width expansion as a negative value and crack width reduction as a positive value. However, the opposite is more intuitive. Therefore, the graphs within this manual will be displayed with positive values as negative ones and negative ones as positive ones. Figure A 41 and Figure A 42 demonstrate this change.

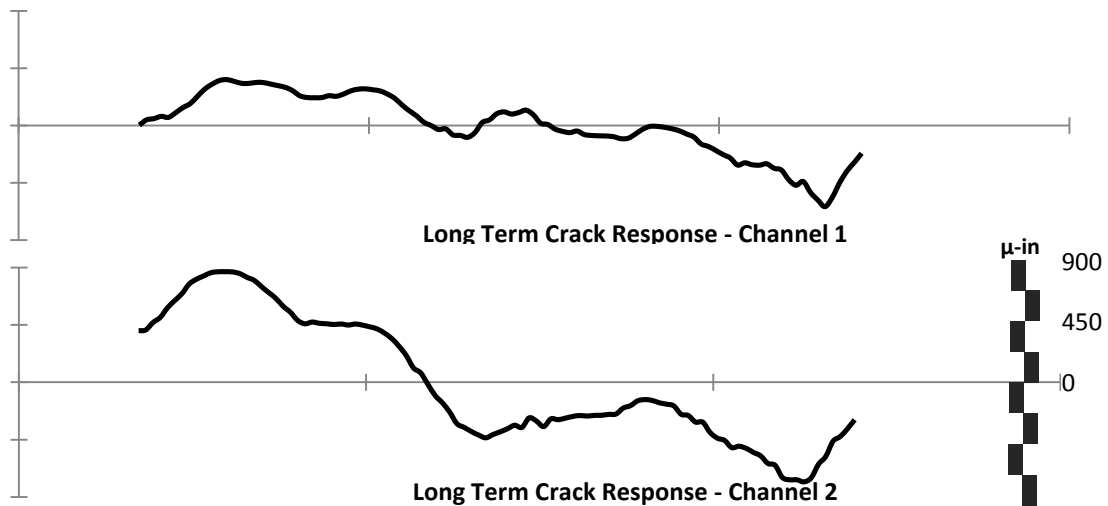

Figure A 41: Original Graph Output with Incorrect Signs on the Data

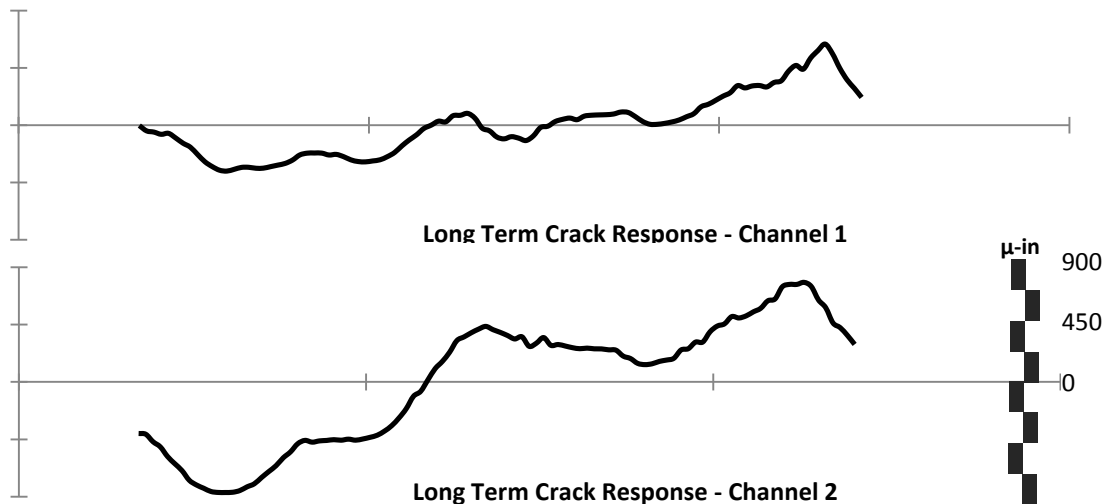

Figure A 42: Corrected Graph Output with Correct Signs on the Data